

Title 51
PUBLIC HEALTH—SANITARY CODE
Part XIII. Sewage Disposal

Chapter 1. General
[formerly Chapter 13 Subpart A]

§101. Definitions
[formerly paragraph 13:001]

A. As used in this Part, the terms defined in this Chapter supplement any definitions which may be set forth in law and shall have the following meanings and/or applications, unless the context or use thereof clearly indicates otherwise, or more explicit definitions and/or applications are referenced. Terms not defined or referenced herein shall have the meanings as defined in the other Parts of the sanitary code of the state of Louisiana. In any instance where a term defined herein is also defined in one or more other Parts of this Code, the definition contained in this Part shall be given preference as it pertains to sewage disposal.

Commercial Treatment Facility (designed in accordance with §503)—any treatment facility which is required by the state health officer whenever the use of an individual sewerage system is unfeasible or not authorized.

Community Sewerage System—any sewerage system which serves multiple connections and consists of a collection and/or pumping/transport system and treatment facility.

Conventional Septic Tank System—a septic tank system which consists of a septic tank(s) followed by a subsurface absorption field.

Facility or Facilities—any or all of the apparatus and appurtenances associated with a sanitary sewage treatment system, element, or process.

Gravelless Pipe—a proprietary device which may be used in lieu of conventional subsurface absorption field materials when approved by the state health officer.

Individual Mechanical Plant—a treatment facility which provides primary and secondary treatment of sanitary sewage by use of aerobic bacterial action which is sustained by mechanical means.

Individual Sewerage System—any system of piping (excluding the building drain), and/or collection and/or transport system which serves one or more connections, and/or pumping facility, and treatment facility, all located

on the property where the sanitary sewage originates; and which utilizes the individual sewerage system technology which is set forth in Chapter 7 Subchapter B of this Part, or a commercial treatment facility which is specifically authorized for use by the state health officer.

Limited Use Sewerage System—a sewerage system which may be authorized by the state health officer for installation or use for a structure or dwelling which is occupied less than four days in a week, and the use of which generates less than 100 GPD of sanitary sewage.

Manufacturer—a person who engages in the business or practice of constructing individual mechanical sewerage treatment systems, and who is responsible for having the system evaluated in compliance with §725.D of this Part.

Person—any natural person, partnership, corporation, association, governmental subdivision, receiver, tutor, curator, executor, administrator, fiduciary, or representative of another person, or public or private organization of any character.

Premises—any structure or dwelling of any construction whatsoever in which a person may live, work, or congregate.

Sanitary Sewage—any and all human waste and/or domestic waste, the disposal of which requires a sewerage system approved or authorized by the state health officer. Sanitary sewage may include its conveying liquid and/or any other liquid or solid material which may be present therein.

Secondary Treatment Standard—a sewage effluent water quality standard which prescribes a maximum 30-day average concentration of biochemical oxygen demand (5-day basis) of 30 milligrams per liter (mg/l), and a maximum daily concentration of biochemical oxygen demand (5-day basis) of 45 mg/l. The 30-day average concentration is an arithmetic mean of the values for all effluent samples collected in the sampling period. The analyses to be performed for the purpose of determining compliance with these effluent

limitations and standards shall be in accordance with the eighteenth edition of the "Standard Methods for the Examination of Water and Wastewater," available from the American Public Health Association 1015 Eighteenth Street NW, Washington, D.C. 20036, except where otherwise specified.

Septic Tank System—an individual sewerage system which consists of a septic tank(s) followed by a process which treats and disposes of the septic tank effluent.

Sewerage System—any system of piping (excluding the building drain and building sewer) and/or collection and/or transport system and/or pumping facility and/or treatment facility, all for the purpose of collecting, transporting, pumping, treating and/or disposing of sanitary sewage.

Subdivision for the purpose of these regulations—

a. the division, or the process or results thereof, of any land into two or more lots, tracts, parcels, or plots, any one of which has an area of less than 3 acres; or

b. the re-subdivision of land heretofore divided into lots, tracts, sites or parcels; provided, however, that minimum lot size restrictions presented in §511.B shall not apply to:

i. a subdivision legally established and recorded prior to July 28, 1967; or

ii. a small parcel of land sold to or exchanged between adjoining property owners, provided that such a sale or exchange does not create additional lots.

c. Note: For the purpose of these regulations, the requirements for wetlands might be more stringent.

Sub-Manufacturer—a person or entity authorized by a licensed manufacturer to construct, or assemble individual sewerage systems, or any portion thereof.

Trailer Coach—any of the various forms of structures which are equipped, or capable of being equipped, with wheels, including, but not limited to, travel trailers, truck coaches or campers, mobile homes, trailers, and/or tent campers, whether capable of moving under its own power or not, and where a person or persons may live, work, or congregate.

Trailer Park—any lot, tract, parcel or plot of land upon which more than one trailer coach is or may be located, and where trailer coach spaces are rented or leased.

AUTHORITY NOTE: The first source of authority for promulgation of the sanitary code is in R.S. 36:258(B), with more particular provisions found in Chapters 1 and 4 of Title 40 of the Louisiana Revised Statutes. This Part is Promulgated in accordance with R.S. 40:4(A)(6) and R.S. 40:5(9)(20).

HISTORICAL NOTE: Promulgated by the Department of Health and Hospitals, Office of Public Health, LR 28:1343 (June 2002).

Chapter 3. General Requirements for Sewerage Disposal [formerly Chapter 13 Subpart B]

§301. Plumbing Fixtures [formerly paragraph 13:002]

A. All premises shall be provided with plumbing fixtures as prescribed in Part XIV of this Code. Such plumbing fixtures shall be connected to a community sewerage system whenever feasible or to an individual sewerage system which is specifically approved for the premises by the state health officer after it is determined that connection to a community sewerage system is unfeasible and that the installation and operation of an individual sewerage system is not likely to create a nuisance or a public health hazard.

AUTHORITY NOTE: Promulgated in accordance with R.S. 40:4(A)(6) and R.S. 40:5(9)(20).

HISTORICAL NOTE: Promulgated by the Department of Health and Hospitals, Office of Public Health, LR 28:1344 (June 2002).

§303. Responsible Parties [formerly paragraph 13:003]

A. A person who owns, operates, manages, or otherwise controls any premises, shall provide for sewage disposal in a manner which is in compliance with this Code.

AUTHORITY NOTE: Promulgated in accordance with R.S. 40:4(A)(6) and R.S. 40:5(9)(20).

HISTORICAL NOTE: Promulgated by the Department of Health and Hospitals, Office of Public Health, LR 28:1344 (June 2002).

§305. Discharges [formerly paragraph 13:004-1]

A. A person shall not directly or indirectly discharge, or allow to be discharged, the contents or effluent from any plumbing fixtures, vault, privy, portable toilet, or septic tank, into any road, street, gutter, ditch, water course, body of water, or onto the surface of the ground.

AUTHORITY NOTE: Promulgated in accordance with R.S. 40:4(A)(6) and R.S. 40:5(9)(20).

HISTORICAL NOTE: Promulgated by the Department of Health and Hospitals, Office of Public Health, LR 28:1344 (June 2002).

§307. Installation
[formerly paragraph 13:004-2]

A. No component part of a sewerage system shall be installed wherever contamination of a ground water supply may occur. The location of any sewerage facility shall not conflict with the placement requirements for a water well which are set forth in Part XII of this Code.

AUTHORITY NOTE: Promulgated in accordance with R.S. 40:4(A)(6) and R.S. 40:5(9)(20).

HISTORICAL NOTE: Promulgated by the Department of Health and Hospitals, Office of Public Health, LR 28:1344 (June 2002).

§309. Previous Permits
[formerly paragraph 13:005]

A. Any permits issued, or approval of plans and specifications granted prior to the effective date of the 1998 revisions of this Part shall remain in effect as it relates to the design of the sewerage system, unless the state health officer determines there exists a need for revision of such permits or approvals.

AUTHORITY NOTE: Promulgated in accordance with R.S. 40:4(A)(6) and R.S. 40:5(9)(20).

HISTORICAL NOTE: Promulgated by the Department of Health and Hospitals, Office of Public Health, LR 28:1344 (June 2002).

Chapter 5. Community Sewerage Systems

[formerly Chapter 13 Subpart C]

§501. Permits
[formerly paragraph 13:006]

A. A person shall not construct or operate a community sewerage system, or make a modification of an existing system which changes the system's capacity, effluent quality, point of discharge, hydraulic or contaminant loadings, or operation of the component units of the system without having first obtained a permit from the state health officer. No community sewerage system shall be constructed, or modified to the extent mentioned above, except in accordance with plans and specifications for installation which have been approved as a part of a permit issued by the state health officer prior to the start of construction or modification.

AUTHORITY NOTE: Promulgated in accordance with R.S. 40:4(A)(6) and R.S. 40:5(9)(20).

HISTORICAL NOTE: Promulgated by the Department of Health and Hospitals, Office of Public Health, LR 28:1344 (June 2002).

§503. Plans
[formerly paragraph 13:007]

A. Detailed plans and specifications for the construction or modification of a community sewerage

system for which a permit is requested shall be submitted by the person who is the owner, his legal agent or who has responsible charge of the facilities. The review and approval of plans and specifications submitted for issuance of a permit will be made in accordance with the design standards presented in "Recommended Standards for Sewage Works," 1990 Edition, promulgated by the Great Lakes and Upper Mississippi River Board of State Sanitary Engineers and available from Health Education Service, P.O. Box 7126, Albany, New York 12224. Proposals which deviate significantly from the standards must be submitted to the state health officer with supporting documentation.

AUTHORITY NOTE: Promulgated in accordance with R.S. 40:4(A)(6) and R.S. 40:5(9)(20).

HISTORICAL NOTE: Promulgated by the Department of Health and Hospitals, Office of Public Health, LR 28:1344 (June 2002).

§505. Operation and Maintenance
[formerly paragraph 13:008-1]

A. All component facilities of a community sewerage system shall, at all times, be maintained in the same configuration as permitted, in working order and operated efficiently to minimize upsets, discharges of excessive pollutants, bypassing of discharges from the system, and health hazards and nuisances. Operator staffing and training, laboratory and process controls, maintenance during normal periods of equipment downtime, backup equipment, and spare parts shall be provided as needed to maintain continuous compliance with the effluent limitations and standards established for the facility by the state health officer and to avoid any bypass or any overflow from the system.

B. [Formerly paragraph 13:008-2] Community sewerage systems shall be operated and maintained so as to consistently produce effluent water quality meeting the minimum requirements of the secondary treatment standard. Additional effluent standards may be established by the state health officer as needed based upon downstream uses of receiving waters.

C. [Formerly paragraph 13:008-3] The bypass of any raw or partially treated sewage from a community sewerage system is prohibited, except where unavoidable to prevent a potential threat to Public Health and Safety or severe property damage, and where no feasible alternatives to bypass exist. The use of alternatives to bypassing,

such as auxiliary treatment facilities, retention of untreated wastes, maintenance during normal periods of equipment downtime, or installation of adequate backup equipment shall be utilized to the maximum extent feasible to avoid bypassing.

AUTHORITY NOTE: Promulgated in accordance with R.S. 40:4(A)(6) and R.S. 40:5(9)(20).

HISTORICAL NOTE: Promulgated by the Department of Health and Hospitals, Office of Public Health, LR 28:1345 (June 2002).

§507. Records
[formerly paragraph 13:009]

A. By request, copies of reports and suitable daily analyses and records of daily operations shall be submitted monthly to the state health officer.

AUTHORITY NOTE: Promulgated in accordance with R.S. 40:4(A)(6) and R.S. 40:5(9)(20).

HISTORICAL NOTE: Promulgated by the Department of Health and Hospitals, Office of Public Health, LR 28:1345 (June 2002).

§509. Land Application
[formerly paragraph 13:010]

A. No sewage sludge, or sewage treatment effluent shall be applied to land for treatment, disposal, irrigation or other purposes without a permit from the state health officer. The Louisiana Department of Environmental Quality should also be contacted regarding other approvals or permits required by that agency for land application projects.

AUTHORITY NOTE: Promulgated in accordance with R.S. 40:4(A)(6) and R.S. 40:5(9)(20).

HISTORICAL NOTE: Promulgated by the Department of Health and Hospitals, Office of Public Health, LR 28:1345 (June 2002).

§511. General Requirements
[formerly paragraph 13:011-1]

A. Connections to Community Sewerage Systems. Where an established community sewerage system (either public or private) is available, and there is ample water supply, all plumbing fixtures within any structure shall be connected to such community sewerage system. Determination by the state health officer of the availability of a community sewerage system shall take into consideration, among other aspects, the separation (both horizontal and vertical) of the structure in question and the sewer main or lateral, political or geographic or legally created boundaries, and the available capacity of the sewer system.

B. [Formerly paragraph 13:011-2] Community Sewerage System Required. Community sewerage systems shall be provided for all new subdivisions and developments where lots are sold or leased. The developer/owner shall be responsible for the provision of adequate sewage treatment and disposal. The use of

individual sewerage systems in lieu of a community sewerage system may be authorized and will be considered under the following circumstances.

1. In subdivisions comprised of less than 125 lots, when the developer submits a comprehensive drainage plan as well as a proposal for restrictive covenants which detail requirements for perpetual maintenance of drainage. This requirement shall apply for all new subdivisions and developments.

2. When the total anticipated design flow to the sewerage system does not exceed 1,500 gpd, and where no food service is involved as per §1301.A.2.

3. On large lots, where an area of one acre or more is involved, having a minimum frontage of 125 feet.

4. The installation would be located on a lot, plot or site which has a minimum area of 22,500 square feet, and a minimum frontage of 125 feet.

5. For subdivisions when each and all lots have a minimum area of at least 22,500 square feet and a minimum frontage of 125 feet, except that the 125 foot frontage requirement may be waived for up to 15 percent of the total number of lots in the development if:

a. minimum frontage on each lot in question is not less than 60 feet, and;

b. the width of each lot in question is at least 125 feet.

6. For parishes in which the parish governing authority has enacted and enforces a formal sewage permitting system (requiring approval of individual sewage disposal systems by the state health officer prior to issuance of any parish permits) and when the lots or sites in question meet any of the following criteria:

a. minimum area of 22,500 square feet and a minimum frontage of 80 feet;

b. minimum area of 16,000 square feet and a minimum frontage of 80 feet where an approved individual mechanical plant is to be utilized;

c. minimum area of 12,000 square feet and a minimum frontage of 60 feet where an approved individual mechanical plant is utilized and is followed by 50 feet of modified absorption field (see Chapter 7 Subchapter B, §733.A).

7. Where lots of "record" (i.e., lots created by formal subdivision prior to July 28, 1967) are combined (in accord with the definition of a subdivision) to create a new, larger, single lot, and no re-subdivision of the property is involved. On July 20, 2002 and thereafter, in no case shall the newly created lots have less than 50 feet of frontage or be less than 5,000 square feet in area.

8. For single lots or sites, regardless of size, remaining in substantially developed previously established subdivisions, when, in the opinion of the state health officer, a hazard to the public health will not result.

9. For single lots or sites, regardless of size, when the installation of an individual sewerage system is proposed in order to renovate or replace a pre-existing sewerage system. Such installation may be allowed when, in the opinion of the state health officer, a public health hazard or nuisance will not result. This provision shall apply to the renovation or replacement of pre-existing systems only and shall not be utilized to circumvent other requirements, particularly those relative to minimum lot size for new residences and subdivision development, of this code.

C. [Formerly paragraph 13:011-3] Effective October 20, 2000, this rule applies to new individual sewerage system installations, upgrades and/or modifications to existing systems required as a result of an investigation by the Office of Public Health (OPH) into an allegation that a violation of Part XIII of the Louisiana sanitary code has occurred or is occurring, and has the potential for causing harm or creating a nuisance to the general public (R.S. 40:1154). Such individual sewerage systems with a capacity up to and including 1,500 gpd, that produce treated effluent, and which, by design, do not significantly reduce the amount of off-site effluent, shall be followed by an effluent reduction system constructed as described in Chapter 7 Subchapter B, §§731 and 733 of this Part.

D. [Formerly paragraph 13:011-4] The state health officer may consider for approval, on an individual basis, proposals for developments that are of a unique nature, such as a development over water, or irregular configuration, where individual sewage disposal is proposed, where the development, by its very nature (e.g., where commonly or jointly owned property is involved), is clearly not addressed by the current considerations of this Code.

AUTHORITY NOTE: Promulgated in accordance with R.S. 40:4(A)(6), R.S. 40:5(9)(20), and R.S. 40:1154(A).

HISTORICAL NOTE: Promulgated by the Department of Health and Hospitals, Office of Public Health, LR 28:1345 (June 2002), amended LR 28:1591 (July 2002).

Chapter 7. Individual Sewerage Systems

[formerly Chapter 13 Subpart D]

Subchapter A. General Requirements

§701. Permits

[formerly paragraph 13:012-1]

A. A person shall not install, cause to be installed, alter subsequent to installation, or operate an individual sewerage system of any kind without first having obtained a permit from the state health officer. No person shall install, cause to be installed, or alter subsequent to installation an individual sewerage system of any kind except in accordance with the plans and specifications for the installation which have been approved as a part of a permit issued by the state health officer. Such permits shall be issued in a two-stage process in accordance with §701.B and C.

B. [Formerly paragraph 13:012-2] Upon receipt of a request for such permit, and approval of plans and specifications for the proposed individual sewerage system (which shall accompany any such request for permit), a temporary permit, authorizing the installation of said system, may be issued. Any such temporary permit shall be in writing and shall not be issued until, with respect to the property and its surroundings, the state health officer has determined that connection to a community-type sewerage system is not feasible, and that the condition of the soil, drainage patterns, the lot size/dimensions, and other related factors are such that the construction and use of properly designed individual sewerage facilities are not likely to create a nuisance or public health hazard.

C. [Formerly paragraph 13:012-3] A final permit approving the installation, shall be issued only upon verification that the individual sewerage system has been installed in compliance with this code. The verification of such installation shall be determined by means of an on-site inspection conducted by a representative of the state health officer and/or in the form of a completed "Certification by Installer" form submitted to the state health officer by the licensed installer. The installer shall notify the appropriate local Parish Health Unit prior to the installation of an individual sewerage system. The

sanitarian shall not issue final approval for this system unless he/she has received a completed and signed certification by installer form. The certification by installer shall be submitted to the state health officer within 15 days after completion of the installation. A final permit shall be issued and provided to the owner/occupant of the premises to be served by the individual sewerage system.

D. [Formerly paragraph 13:012-4] If a consumer currently owns, is contemplating purchasing and having installed, or is an installer of Individual Mechanical Sewage Treatment Plants, that consumer should be made aware that:

1. it has become apparent that the electrical components of Individual Mechanical Sewage Treatment Plants which require connection to a source of electricity may not be properly connected to that electrical source in some cases. Specifically, mechanical sewage treatment plants, using electrical power may require a properly installed Ground Fault Current Interrupter (GFCI);

2. the Office of Public Health has specific statutory authority and mandates to protect the public health from the improper treatment and disposal of sewage. This office will offer the public consultation with regard to the appropriate sewage treatment system that should be used in a specific application, considering system design for properly treating sewage, sizing for the number of people using the system, location of the system, and other health considerations, as necessary. However, the Office of Public Health does not have the authority to inspect or approve electrical connections, are not qualified in the area of such electrical connections and will not assume responsibility for such electrical safety considerations;

3. accordingly, proper electrical connections must be made to the air pump/blower and/or any other electrical components that are integral parts of an individual mechanical sewage treatment plant, and that a qualified electrician should perform or examine the installation(s) for appropriate wiring and installation, as well as the connection to the ground fault current interrupter.

E. [Formerly paragraph 13:012-5] Permits for the installation of individual sewerage systems shall not be issued for lots within a formal subdivision unless an official recorded plat/property survey has been filed with and subsequently approved for use of individual sewerage systems by the Office of Public Health.

AUTHORITY NOTE: Promulgated in accordance with R.S. 40:4(A)(6) and R.S. 40:5(9)(20).

HISTORICAL NOTE: Promulgated by the Department of Health and Hospitals, Office of Public Health, LR 28:1346 (June 2002).

§703. Plans
[formerly paragraph 13:013-1]

A. The review and approval of plans and specifications for the proposed individual sewerage system shall be made in accordance with the "Regulations Controlling the Design and Construction of Individual Sewage Systems" (See Chapter 7, Subchapter B).

B. [Formerly paragraph 13:013-2] Individual sewerage systems, other than conventional septic tank systems, i.e., septic tanks followed by a subsurface disposal system, including those facilities built in conflict with the state of Louisiana sanitary code, shall comply with all provisions of the Louisiana Department of Environmental Quality Wastewater Discharge Permit. The Louisiana Department of Environmental Quality should be contacted for information regarding wastewater discharge permits. The state health officer may establish other limitations or standards, as needed, in consideration of the water quality of affected surface water bodies and groundwaters.

AUTHORITY NOTE: Promulgated in accordance with R.S. 40:4(A)(6) and R.S. 40:5(9)(20).

HISTORICAL NOTE: Promulgated by the Department of Health and Hospitals, Office of Public Health, LR 28:1347 (June 2002).

§705. Installation of Individual Sewerage Systems
[formerly paragraph 13:014-1]

A. A person who wishes to engage in the business of installing or providing maintenance of individual sewerage systems shall obtain, in accordance with the procedures set forth in §737 of this Part, a license for such activity prior to making any such installations or providing maintenance. Such a license shall not be required, however, for an individual wishing to install an individual sewerage system, other than an individual mechanical plant, for his own private, personal use. Individual mechanical plants shall be installed and maintenance provided by licensed individual sewerage system installers and/or maintenance providers only.

B. [Formerly paragraph 13:014-2] A person installing or providing maintenance of an individual sewerage system and the person who is the owner of the premises shall be responsible for compliance with §§701 and 703.

AUTHORITY NOTE: Promulgated in accordance with R.S. 40:4(A)(6) and R.S. 40:5(9)(20).

HISTORICAL NOTE: Promulgated by the Department of Health and Hospitals, Office of Public Health, LR 28:1347 (June 2002).

§707. Maintenance and Operation
[formerly paragraph 13:015]

A. Individual sewerage systems shall be kept in service and in a serviceable condition sufficient to insure compliance with this code and in order to avoid creating or contributing to a nuisance or a public health hazard.

AUTHORITY NOTE: Promulgated in accordance with R.S. 40:4(A)(6) and R.S. 40:5(9)(20).

HISTORICAL NOTE: Promulgated by the Department of Health and Hospitals, Office of Public Health, LR 28:1347 (June 2002).

§709. Septic Tank Systems
[formerly paragraph 13:016]

A. Where a community-type sewerage system is not available, a septic tank system may be used provided that the requirements of §§511.B, 701, 703.A, and 705 are complied with.

AUTHORITY NOTE: Promulgated in accordance with R.S. 40:4(A)(6) and R.S. 40:5(9)(20).

HISTORICAL NOTE: Promulgated by the Department of Health and Hospitals, Office of Public Health, LR 28:1347 (June 2002).

§711. Individual Mechanical Plants
[formerly 13:017-1]

A. An individual mechanical plant may be used where a community-type system is not available, and where the state health officer determines that a conventional septic tank system (septic tank-absorption field) would not be expected to function properly, and where the requirements of §§511.B, 701, 703.B, and 705 are complied with.

B. [Formerly paragraph 13:017-2] Permits, per the requirements of §701, for the installation of individual mechanical plants, shall not be issued except and unless the manufacturer of the mechanical plant has received a manufacturer's license in accordance with the requirements of §735.A, and has received appropriate certification from DHH/OPH.

AUTHORITY NOTE: Promulgated in accordance with R.S. 40:4(A)(6) and R.S. 40:5(9)(20).

HISTORICAL NOTE: Promulgated by the Department of Health and Hospitals, Office of Public Health, LR 28:1347 (June 2002).

§713. Other Individual Sewerage Systems
[formerly paragraph 13:018-1]

A. Where a person proposes innovative processes or design features other than those described in Chapter 7 Subchapter B of this Part, a limited number of experimental or developmental installations may be approved where: either failure of the installation or

insignificant benefits to performance and cost is not expected, based on current engineering data and literature. The total number of such installations shall not exceed three throughout the state and shall be approved under the following conditions.

B. [Formerly paragraph 13:018-2] Each installation shall be installed only in accordance with plans and specifications and testing procedures which have been specifically approved for each installation as a part of a permit issued by the state health officer prior to the installation.

C. [Formerly paragraph 13:018-3] The permit for each installation shall be for a period of one year and may be renewed under the provisions of §713.

D. [Formerly paragraph 13:018-4] Should an innovative process fail, the owner of the premises and the person proposing the innovative process shall upgrade or replace the installation to bring it into compliance with the applicable provisions of this Part.

E. [Formerly paragraph 13:018-5] After the experimental or developmental use of an installation is completed, the permit issued under this Section may be revised to remove the restrictions cited in Subsections 713.B and C if the state health officer determines that the available data show that continued use of the installation will not result in non-compliance with applicable provisions of this Chapter. Such a revision of a permit issued under §713 shall apply only to the individual installation approved under that permit, and should not be construed as being an approval of the system design for other existing or future installations.

F. [Formerly paragraph 13:018-6] Proprietary Devices. Proprietary devices are all devices designed to reduce, process, and treat all or a select portion of wastewater generated within the individual home. This includes water recycle and reuse devices, water conservation devices, composting units, and other devices intended to reduce the volume of waste generated or water consumed. The approval of a proposal to utilize a proprietary device may only be granted by the state health officer.

AUTHORITY NOTE: Promulgated in accordance with R.S. 40:4(A)(6) and R.S. 40:5(9)(20).

HISTORICAL NOTE: Promulgated by the Department of Health and Hospitals, Office of Public Health, LR 28:1347 (June 2002).

Subchapter B. Design and Construction Regulations [formerly Chapter 13 Appendix A]

§715. Septic Tanks [formerly Section I of Appendix A]

A. [Formerly paragraph A:1.1 of Appendix A] A septic tank is a watertight tank made of steel, concrete or other approved materials in which the settleable solids of sewage settle out and are largely changed into liquids or gases by bacterial decomposition. The remaining residue in the tank is a heavy, black semi-liquid sludge which must be removed from the tank periodically. Although the completely digested sludge contains relatively few disease germs, in cleaning the tank it is impossible to remove the digested sludge without removing some undigested material. Therefore, it is particularly important that the removed sludge be disposed of in a safe manner. There are commercial service companies that will contract for septic tank cleaning and sludge disposal. Such commercial services are controlled by a permit system in accordance with §901 of this Part.

B. [Formerly paragraph A:1.2 of Appendix A] Multiple compartment septic tanks or single chamber septic tanks in series provide more effective treatment than single chamber tanks of the same total capacity; therefore, the use of multiple compartment tanks or single tanks in series is encouraged. However, single chamber septic tanks are acceptable.

C. [Formerly paragraph A:1.3 of Appendix A] The velocity of flow through the tanks must be such that maximum solids and scum retention is achieved. Vertical cylindrical tanks must have horizontal (inlet-to-outlet) separation of at least 24 inches.

1. Tees or baffles must be used at the inlet. The outlet must be designed so as to preclude floating solids from escaping from the tank. The inlet tee or baffle diverts the incoming sewage toward the bottom of the tank without disturbing the scum which forms on the surface of the liquid, and the outlet prevents the surface scum from flowing out of the tank.

D. [Formerly paragraph A:1.4 of Appendix A] The minimum total septic tank liquid capacity required is 2 1/2 times the estimated average daily design flow. Sewage loading criteria for determining the average daily design flow and organic loading are contained in Chapter 15 of this Part. One-bedroom residences may, however, utilize a 500 gallon tank.

NOTE: The minimum allowable total septic tank volume for all applications is 500 gallons.

E. [Formerly paragraph A:1.5 of Appendix A] The distance between the inlet and outlet openings in the tank wall, measured horizontally, shall be not less than 24 inches. The distance between the inlet and outlet shall exceed the width of rectangular and oval-shaped tanks.

F. [Formerly paragraph A:1.6 of Appendix A] The tank shall operate with a liquid depth between a minimum of 30 inches and a maximum of 72 inches measured vertically from the invert of the outlet (overflow level) to the bottom of the tank. Recent septic tank studies have indicated the shallower tank to be more efficient and is therefore preferred.

G. [Formerly paragraph A:1.7 of Appendix A] For tanks having straight vertical sides, the dimension between the top of the tank and the liquid level shall not be less than 15 percent of the liquid depth. In horizontal cylindrical tanks, the volume of the air space above the liquid shall not be less than 15 percent of the liquid capacity. In the latter case, this condition is met if the liquid depth (distance from outlet invert to bottom of tank) is at least 79 percent of the diameter of the tank.

H. [Formerly paragraph A:1.8 of Appendix A] A single tank may be divided into two or more compartments by means of internal partitions. Each compartment shall conform to the dimensions limitations for complete tanks and shall have a liquid capacity of at least 250 gallons. The total liquid capacity shall conform to the requirements for single chamber tanks. No tanks shall have more than three compartments.

I. [Formerly paragraph A:1.9 of Appendix A] The tank shall be constructed of materials which are corrosion resistant and provide a watertight permanent structure. The cover of the tank shall be designed for a dead load of not less than 150 pounds per square foot. Concrete covers must be reinforced with steel and must be not less than 4 inches thick. Metal septic tanks shall comply with the requirements of §715.O. Tanks of other materials such as fiberglass will be reviewed for acceptance on an individual basis. They will be required to comply generally with the basic applicable standards for metal septic tanks.

J. [Formerly paragraph A:1.10 of Appendix A] Access to the septic tank for cleaning and inspection shall be provided by a removable cover or manhole. Both inlet and outlet devices as well as each compartment in multiple compartment tanks must be accessible. Manholes, when used shall be at least 20 inches square or 24 inches in diameter and provided with covers which can be sealed watertight. Septic tanks with removable covers must be provided with an 8-inch inspection hole over the inlet and the outlet.

K. [Formerly paragraph A:1.11 of Appendix A] Either tees or baffles shall be provided at the inlet of the tank and shall extend upward at least 6 inches above the liquid level of the tank. The inlet tee or baffle shall extend downward to at least 6 inches below the liquid level, but it shall not extend below the level of the lower end of the outlet tee or baffle. At least 2 inches of open space shall be provided above the baffle or tee to provide ventilation to the tank through the building plumbing system.

L. [Formerly paragraph A:1.12 of Appendix A] On the outlet side the tee or baffle shall extend downward to a distance below the water surface equal to 40 percent of the liquid depth of tanks with vertical sides and 35 percent of liquid depth of tanks of other shapes as measured to the nearest inch. If a tee or baffle is used in the outlet the upper end shall extend 6 inches above the liquid level.

M. [Formerly paragraph A:1.13 of Appendix A] Inlet and outlet fittings (tees or ells) must be of cast iron, schedule 40 PVC or ABS plastic or other approved material.

N. [Formerly paragraph A:1.14 of Appendix A] The invert of the inlet shall be located at least 2 inches above the invert of the outlet.

O. [Formerly paragraph A:1.15 of Appendix A] Metal septic tanks shall be prefabricated of a minimum of 14 gauge commercial grade steel. Corrosion protection shall, at a minimum, consist of a hot-dipped asphalt coating of at least 0.025-inch thickness properly applied to all surfaces of the new, clean, bare metal.

P. [Formerly paragraph A:1.16 of Appendix A] The location of a septic tank shall comply with minimum distance requirements from water wells, water lines, etc. as contained in Part XII, of this Code.

Q. [Formerly paragraph A:1.17 of Appendix A] The use of septic tanks in series is encouraged. The first tank shall have at least a 500-gallon liquid capacity and all

subsequent tanks shall have at least 300-gallon liquid capacities. The total capacity of all tanks in series must comply with the capacities for septic tanks as prescribed in §715.D.

R. [Formerly paragraph A:1.18 of Appendix A] Piping from the house to the septic tank must be such that the waste flow does not disturb the retention of scum and sludge in the tank. To attain this, the inlet piping from the house must have a minimum diameter of four inches and be laid on a slope of at least 1/8 inch per foot. The slope for the last 10 feet of line preceding the septic tank must not exceed 1/4 inch per foot. All plastic piping, excluding perforated pipe, must be a minimum of SDR 35 sewer and drainage pipe or equivalent.

S. [Formerly paragraph A:1.19 of Appendix A] Backfill around septic tanks must be made in thin layers thoroughly tamped in a manner that will not produce undue strain on the tank. Sufficient soil cover can be provided over the top of the septic tank to permit grass growth. However, no other obstruction to access (i.e., concrete slabs, buildings, etc.) shall be allowed.

T. [Formerly paragraph A:1.20 of Appendix A] Septic tanks should be inspected every six years and pumped at least every eight years by a licensed sewage hauler.

U. [Formerly paragraph A:1.21 of Appendix A] Untreated or uncoated metal septic tanks shall not be used.

V. [Formerly paragraph A:1.22 of Appendix A] Abandoned septic tanks (tanks no longer in active use) shall be pumped out by a licensed sewage hauler, then removed or the cover discarded and the tank filled with soil to natural grade. The contents of the abandoned tank shall not be placed into a newly installed individual sewerage system.

AUTHORITY NOTE: Promulgated in accordance with R.S. 40:4(A)(6) and R.S. 40:5(9)(20).

HISTORICAL NOTE: Promulgated by the Department of Health and Hospitals, Office of Public Health, LR 28:1348 (June 2002).

§717. Septic Tank Effluent [formerly Section II of Appendix A]

A. [Formerly paragraph A:2.1 of Appendix A] There is a common belief that sewage after treatment in a septic tank is pure water, or very nearly so. This is false. The effluent or liquid flowing from the tank is still foul and dangerous. The septic

tank cannot be depended upon to remove disease germs. The discharge of the effluent from septic tanks into street gutters, surface ditches, or streams is prohibited.

B. [Formerly paragraph A:2.2 of Appendix A] The treatment level of a septic tank is referred to as primary treatment.

C. [Formerly paragraph A:2.3 of Appendix A] The preferred method of treatment for septic tank effluents is accomplished through the use of soil absorption trenches. Small oxidation ponds or sand filter beds may be used in lieu of absorption trenches only where soil and drainage conditions or available space prevent the use of absorption trenches. The level of treatment of these units is referred to as secondary treatment.

D. [Formerly paragraph A:2.4 of Appendix A] The use of absorption trenches, oxidation ponds and filter beds for the treatment of septic tank effluents is discussed in detail in the following Paragraphs of these standards.

AUTHORITY NOTE: Promulgated in accordance with R.S. 40:4(A)(6) and R.S. 40:5(9)(20).

HISTORICAL NOTE: Promulgated by the Department of Health and Hospitals, Office of Public Health, LR 28:1349 (June 2002).

§719. Absorption Trenches
[formerly Section III of Appendix A]

A. [Formerly paragraph A:3.1 of Appendix A] Where soil conditions are satisfactory and sufficient land is available, septic tank effluent shall be disposed of in absorption trenches. This consists of a system of covered gravel (or other approved aggregate) filled trenches into which the septic tank effluent is applied so as to permit the liquid to seep into the soil. By action of microorganisms in the soil, the organic matter is converted into mineral compounds.

B. [Formerly paragraph A.3.2 of Appendix A] A number of variables determine whether an absorption trench is feasible, including: soil porosity (permeability), ground water table, available space, and the rate at which septic tank effluent enters the soil (percolation rate). In general three conditions should be met.

1. The soil percolation rate must be within the acceptable range.

2. The maximum elevation of the ground water table should be at least 2 feet below the bottom of the proposed trench system.

3. Clay formations or other impervious strata should be at a depth greater than 4 feet below the bottom of the trenches.

C. [Formerly paragraph A.3.3 of Appendix A] Unless these conditions are satisfied, the site is unsuitable for a subsurface sewage disposal system, and an alternative method must be utilized.

D. [Formerly paragraph A.3.4 of Appendix A] The acceptability of soil for an absorption trench system and the required size of such a system is currently based upon the "Percolation Test" described below.

1. Three or more tests must be made in separate test holes spaced uniformly over the proposed absorption field site.

2. Dig or bore a hole, with horizontal dimensions of from 4 to 12 inches and vertical sides to the depth of the proposed absorption trench. In order to save time, labor, and volume of water required per test, the holes may be bored with a 4-inch auger.

3. Carefully scratch the bottom and sides of the hole with a knife blade or sharp-pointed instrument in order to remove any smeared soil surfaces and to provide a natural soil interface into which water may percolate. Remove all loose material from the hole.

4. To conduct the test, fill the hole with clear water. This pre-wetting procedure should normally be accomplished on the day prior to the percolation rate measurement. This procedure is to insure that the soil is given ample opportunity to swell and to approach the operating condition of the wet season of the year. Thus, the test should give comparable results in the same soil whether made in a dry or in a wet season.

5. With the exception of sandy soils, percolation rate measurements shall be made on the day following the procedure described under §719.D.4 above. Add water until the liquid depth is at least 6 inches, but not more than 12 inches from a fixed reference point. Measure the drop in water level over a 60-minute period. This drop is used to calculate the percolation rate. Section 1501.B.1 (Figure 1) shows methods of percolation rate measurement. If the drop in liquid depth in the first 30 minutes is less than one inch, it is unnecessary to continue the test for the full 60-minute period.

6. The distance the water falls in 60 minutes in each of the three test holes is recorded. The average drop for the three holes is used to determine the

total length of absorption trench from Table 1 below.

| Table 1 Absorption Trench Length Requirements for Individual Residences | |
|--|--|
| Average Water Level Drop in 60 minutes (in inches) | Length (in Feet) of Absorption Trenches Required per Bedroom* |
| More than 12 | 72 |
| 12 | 83 |
| 11 | 87 |
| 10 | 91 |
| 9 | 96 |
| 8 | 100 |
| 7 | 104 |
| 6 | 110 |
| 5 | 117 |
| 4 | 127 |
| 3 | 142 |
| Less than 3 | Not acceptable for absorption field |

NOTE: A minimum of 160 linear feet of field line shall be provided.
 *-or per 150 gpd of design flow for non-residential applications.

E. [Formerly paragraph A:3.5 of Appendix A] Many different designs may be used in laying out an absorption trench system. The choice will depend on the size and shape of the available disposal area, the capacity required and the topography of the area.

F. [Formerly paragraph A:3.6 of Appendix A] The septic tank effluent is applied to the absorption field through a system of level bottomed trenches. Conventional field lines are laid on a slope of 2 to 3 inches per 100 feet. Gravelless pipe and other distribution chambers must be laid as close as possible to a slope of 1 inch per 100 feet. A distribution box may be required for equal distribution of the effluent. Section 1501.B.2 and 3 (Figure 2 and 3) show a typical layout of a conventional absorption trench system for flat and sloping areas.

G. [Formerly paragraph A:3.7 of Appendix A] To provide the minimum required backfill depth and earth cover, the depth of the absorption trenches must be a minimum of 18 inches. Additional depth may be needed for contour adjustment for extra backfill under the distribution line or for other design purposes. However, the total depth must not exceed 24 inches.

H. [Formerly paragraph A:3.8 of Appendix A] Careful construction is important in obtaining a satisfactory soil absorption system. Section 1501.B.4 (Figure 4) shows details for absorption trench construction.

I. [Formerly paragraph A:3.9 of Appendix A] Individual trenches shall not be greater than 100 feet in length and not less than 18 inches in width. The center line distance between individual trenches shall be at

least 6 feet. In addition, the absorption trenches shall be located at least 10 feet from any dwelling or property line.

J. [Formerly paragraph A:3.10 of Appendix A] The location of the absorption trenches shall comply with minimum distance requirements from water wells, water lines, etc., as contained in Part XII of this Code.

K. [Formerly paragraph A:3.11 of Appendix A] In every case, at least two trenches shall be used.

L. [Formerly paragraph A:3.12 of Appendix A] Trench bottoms must be level to promote even distribution, thereby minimizing premature failure of a portion of the trench. During excavation, attention must be given to the protection of the soil. Care must be taken to prevent sealing of the surface on the bottom and sides of the trench. Trenches should not be excavated when the soil is wet enough to smear or compact easily. All smeared or compacted surfaces must be raked to a depth of 1 inch and loose material removed before the backfill is placed in the trench.

M. [Formerly paragraph A:3.13 of Appendix A] Conventional field lines shall consist of perforated non-metallic pipe meeting one of the following standards.

| |
|--|
| PVC sewer pipe and fittings (Thin wall), ASTM D2729-93 |
| Smooth wall polyethylene (PE) pipe, ASTM F810-93, for use in waste disposal absorption fields; |
| SRP pipe and fittings, ASTM D2852-93. |

1. In every case, the minimum acceptable diameter is 4 inches. Although the trench bottom is level, conventional field pipes must be laid on a slope of between 2 to 3 inches per 100 feet to provide even distribution of the liquid throughout the trench.

N. [Formerly paragraph A:3.14 of Appendix A] Where conventional field pipe is used, it must be surrounded by clean graded gravel or rock, broken, hard-burned clay brick or similar material. The bed material may range in size from 1/2 inch to 2.5 inches. The gravel must extend from at least 2 inches above the top of the pipe to at least 6 inches below the bottom of the pipe. The top of the stone should be covered with either untreated building paper, or similar pervious material to

prevent the gravel from becoming clogged by the earth backfill [see §1501.B.4 (Figure 4)].

O. [Formerly paragraph A:3.15 of Appendix A] Where gravelless pipe or distribution chambers are used, the fill must be porous soil or sand which allows the passage of water in all directions with a 6-inch layer below the pipe and filled 4 to 6 inches above grade and spread 3 to 4 feet on either side of the trench. Only gravelless pipe or other distribution chambers specifically approved for use in Louisiana by the state health officer may be used. The total length of gravelless distribution products required is the same as for conventional absorption trenches.

P. [Formerly paragraph A:3.16 of Appendix A] For an absorption trench to work properly, it must have access to air, generally through the soil interstices of the backfill. Therefore, the absorption trench should be backfilled with 4 to 12 inches of pervious soil, hand-tamped and then overfilled with about 4 to 6 inches of earth. Care should be taken to avoid compacting of the backfill.

Q. [Formerly paragraph A:3.17 of Appendix A] All of the above listed requirements, with the exception of the protection of water supplies, are aimed at preventing absorption trench clogging and premature failure. In addition, the septic tank should be inspected every six years after installation and pumped, as necessary, to prevent solid overflow to the soil absorption system and subsequent clogging and failure.

R. [Formerly paragraph A:3.18 of Appendix A] Absorption trenches shall not be located:

1. beneath driveways, parking or other paved areas;
2. in areas that may be subjected to passage or parking of heavy equipment or vehicles, or storage of materials;
3. beneath buildings or other structures.

AUTHORITY NOTE: Promulgated in accordance with R.S. 40:4(A)(6) and R.S. 40:5(9)(20).

HISTORICAL NOTE: Promulgated by the Department of Health and Hospitals, Office of Public Health, LR 28:1349 (June 2002).

§721. Oxidation Ponds [formerly Section IV of Appendix A]

A. [Formerly paragraph A:4.1 of Appendix A] An oxidation pond is a shallow pond designed specifically to treat sewage by natural purification processes under the influence of air and sunlight. The stabilization process consists largely of the interactions of bacteria and algae.

Bacteria digest and oxidize the constituents of sewage and render it harmless and odor free. Algae utilize carbon dioxide and other substances resulting from bacterial action and through photosynthesis produce the oxygen needed to sustain the bacteria in the treatment process. During the detention period, the objectionable characteristics of the sewage largely disappear.

B. [Formerly paragraph A:4.2 of Appendix A] The minimum surface area of an oxidation pond must be no less than 400 square feet with a 4 to 5 foot average liquid depth and vertical side walls. This minimum size pond is adequate for design flows of up to 400 gallons/day (gpd). For design flows in excess of 400 gpd, the pond area must be increased to provide sufficient volume (at the 4 foot depth) to hold 30 days worth of flow (a 30-day retention period). For wastes with high BOD loadings, special consideration for increasing pond size must be given.

C. [Formerly paragraph A:4.3 of Appendix A] Section 1501.B.5 (Figure 5) shows a typical layout for a septic tank-oxidation pond system. The actual layout of any pond system will be governed to a great extent by the topography of the particular location. However, an oxidation pond must be located so as to comply with the minimum distance requirements from water wells, lines, etc., as contained in Part XII of this Code. It is also desirable for aesthetic reasons to locate it as far as possible, but at least 50 feet from any dwelling and no less than 20 feet from the property line to water's edge at normal operating line.

D. [Formerly paragraph A:4.4 of Appendix A] As mentioned, the use of the minimum surface area of 400 square feet requires that an oxidation pond be furnished with vertical side walls so that an adequate volume for treatment is provided. Section 1501.B.6 (Figure 6) shows a type of construction utilizing treated timber which under normal soil conditions is acceptable for the vertical side walls of a 20 foot by 20 foot oxidation pond with a 5 foot average water depth. Section 1501.B.7 (Figure 7) shows a similar type of construction utilizing concrete blocks. Either of these designs requires very little maintenance.

E. [Formerly paragraph A:4.5 of Appendix A] Vertical side walls must be of cypress or treated

timbers or concrete blocks and so constructed as to provide a permanent structure.

F. [Formerly paragraph A:4.6 of Appendix A] Although not encouraged, a pond may be constructed with sloping sides and earthen levees. Such a design is shown in §1501.B.8 (Figure 8). The design requires a minimum surface area of 625 square feet with a 5 foot liquid depth at the center in order to achieve the required volume. The cost of this design is less than that of the vertical wall ponds referred to above, but more space is needed and routine maintenance requirements such as levee mowing are greater. The slope of the natural earth side walls must not be shallower than one-to-one (45-degree angle) [see §1501.B.8 (Figure 8)].

G. [Formerly paragraph A:4.7 of Appendix A] A septic tank must precede the oxidation pond and must comply with the septic tank requirements presented in these regulations.

H. [Formerly paragraph A:4.8 of Appendix A] The pipe from the septic tank to the pond as well as the outfall pipe from the pond must be at least 4 inches in diameter and placed at a minimum slope of 2 inches per 100 feet. The inlet must extend 4 to 6 feet horizontally into the pond and be directed downward at least 1 1/2 to 2 feet below the liquid surface level. The outlet must extend 4 to 6 feet horizontally into the pond and consist of a tee with the invert set at the operating water level of the pond. One leg of tee must be open and extend above the water level, while the down leg is extended 1 1/2 to 2 feet below the water level. The invert of the pond outlet must be lower than the pond inlet invert [see §1501.B.8 (Figure 8)]. Additionally the invert of the pond inlet must be at least 2 inches lower than the invert of the septic tank outlet.

I. [Formerly paragraph A:4.9 of Appendix A] The pond shall be enclosed by a suitable non-climbable fence to keep out children, pets and livestock. An open type fence (woven wire) is preferable because it will not restrict sunlight and air which are necessary for the treatment. The fence shall be at least 5 feet in height and be provided with a locked gate.

J. [Formerly paragraph A:4.10 of Appendix A] Abandoned oxidation ponds (ponds no longer in active use) shall be dewatered, allowed to dry and then filled with soil to natural grade.

AUTHORITY NOTE: Promulgated in accordance with R.S. 40:4(A)(6) and R.S. 40:5(9)(20).

HISTORICAL NOTE: Promulgated by the Department of Health and Hospitals, Office of Public Health, LR 28:1351 (June 2002).

§723. Sand Filter [formerly Section V of Appendix A]

A. [Formerly paragraph A:5.1 of Appendix A] Another alternative for the secondary treatment of septic tank effluent is a deep-type sand filter bed. Treatment in a sand filter bed is accomplished by the action of microorganisms in a sand bed in which the suspended solids of the septic tank effluent have been trapped by filtration. It is important that the sand bed remain aerobic throughout the treatment process. This is accomplished by exposing the sand surface to the air as much as possible on a continuous basis. Of course, the best way this can be done is to place no cover whatsoever over the sand bed. Since this is not aesthetically desirable for homes, a coarse gravel cover of clean, washed gravel, not to exceed 6 inches in depth over the bed is permitted. No other cover is acceptable. A filter bed system is shown in §1501.B.9 (Figure 9).

B. [Formerly paragraph A:5.2 of Appendix A] The sand filter bed is constructed by placing perforated pipe near the bottom of a rectangular area of the required size in a layer of gravel covered by a layer of coarse sand 24 inches deep. On top of this are placed distribution lines (perforated pipe) likewise encased in a layer of gravel [see §1501.B.10 (Figure 10)]. The septic tank effluent is distributed speedily in the gravel cover spreading over the top of the sand seeping slowly and vertically through the sand to the bottom layer of gravel to be carried away in the under drain line.

C. [Formerly paragraph A:5.3 of Appendix A] Sand filter beds are to be constructed with a minimum width of 12 feet and a minimum length of 25 feet. This minimum size filter bed is adequately sized for design flows of up to 400 gpd. For greater design flows, the required length shall be increased by eight feet for each additional 150 gpd or portion thereof.

D. [Formerly paragraph A:5.4 of Appendix A] The bed must be drained completely. This may require the bed to be raised above natural ground level.

E. [Formerly paragraph A:5.5 of Appendix A] To prevent sand infiltration into the underdrain, a layer of graded gravel must be placed over the underdrain line and the entire bottom of the filter bed. All gravel must be clean and washed.

F. [Formerly paragraph A:5.6 of Appendix A] Filter sand shall conform to the following standard specifications.

| U.S. Sieve Size | Tyler Screen Size | % Passing (By Weight) |
|-----------------|-------------------|-----------------------|
| Number 4 | Number 4 | 95-100 |
| | Number 14 | 60-80 |
| Number 16 | Number 28 | 5-20 |
| Number 50 | Number 48 | 0-5 |
| Number 100 | Number 100 | 0 |

G. [Formerly paragraph A:5.7 of Appendix A] At least two distribution lines must be provided and they must be sloped 2 inches to 3 inches per 100 feet. The lines must be 4-inch diameter, 20-inch long farm tile, 2 feet to 3-foot lengths of vitrified clay bell-and-spigot sewer pipe laid with open joints, or perforated nonmetallic pipe meeting one of the standards cited in §719.M. The ends of the distribution lines must be half-closed [see §1501.B.10 (Figure 10)].

H. [Formerly paragraph A:5.8 of Appendix A] Underdrain pipe materials are the same as those for the distribution pipe, however, the slope must be no less than 4 inches per 100 feet.

I. [Formerly paragraph A:5.9 of Appendix A] The filter bed must be appropriately protected from surface runoff water.

J. [Formerly paragraph A:5.10 of Appendix A] The filter bed must be located no less than 10 feet from the property line.

K. [Formerly paragraph A:5.11 of Appendix A] The location of the filter bed shall comply with minimum distance requirements from water wells, water lines, etc., as contained in Part XII of this Code.

AUTHORITY NOTE: Promulgated in accordance with R.S. 40:4(A)(6) and R.S. 40:5(9)(20).

HISTORICAL NOTE: Promulgated by the Department of Health and Hospitals, Office of Public Health, LR 28:1352 (June 2002).

*Editor's Note: The address cited in §725.G has changed to:
 Department of Health and Hospitals
 Office of Public Health
 Engineering Services Section
 P.O. Box 4489
 Baton Rouge, LA 70821-4489

**§725. Mechanical Waste Water Treatment Plants
 [formerly Section VI of Appendix A]**

A. [Formerly paragraph A:6.1 of Appendix A] Mechanical wastewater treatment plants are small plants capable of providing primary and secondary treatment of sanitary sewage. All are considered to be aerobic treatment units.

B. [Formerly paragraph A:6.2 of Appendix A] An individual mechanical plant will be permitted where individual sewerage systems would currently be permitted under prevailing rules as set forth in this Part of the state sanitary code. Sewage loading criteria for determining the average daily design flow and organic loading are contained in Chapter 15 of this Part.

C. [Formerly paragraph A:6.3 of Appendix A] An individual mechanical plant will be permitted in lieu of a conventional septic tank system (septic tank/absorption field) only in accordance with the provisions of §511.B of this Code, and where a conventional septic tank system could not be permitted.

D. [Formerly paragraph A:6.4 of Appendix A] Permitted individual mechanical plants shall strictly comply with National Sanitation Foundation International Standard, NSF 40-1996 for Residential Wastewater Treatment Systems (Class I Systems) as revised May 1996 and published by NSF International, P.O. Box 130140, Ann Arbor, Michigan 48113-0140 USA, and as has been approved by the American National Standards Institute, 11 West 42nd Street, New York, New York 10036 as standard ANSI/NSF 40-1996, revised May 28, 1996.

E. [Formerly paragraph A:6.5 of Appendix A] All individual mechanical plants currently approved for installation in Louisiana as of the effective date of these regulations shall not be required to meet the requirements of §725.D until March 1, 2001. Until March 1, 2001, plants shall continue to comply with the standards under which they were approved. Effective March 1, 2001, all plants shall comply with the standard as stated in §725.D.

F. [Formerly paragraph A:6.6 of Appendix A] In addition to evidence of strict compliance with NSF International Standard NSF 40-1996 (Class I Systems), and ANSI/NSF 40-1996 (Class I Systems), as are specified in §725.D of this Code, the following Department of Health and Hospitals/Office of Public Health (DHH/OPH) requirements shall also apply.

1. Testing/Evaluation (General)

a. All certifications of individual mechanical plants shall be conducted by an American National Standards Institute (ANSI) accredited certification program testing/evaluation facility authorized for such purpose(s). Verification of such certification shall be provided to DHH/OPH, subject to

acceptance by DHH/OPH of such verification, as prerequisite to consideration of any individual mechanical (residential) plant for permitting in Louisiana.

b. Evidence of acceptance by DHH/OPH of an ANSI accredited testing/evaluation facility, for purpose of testing/evaluation of individual mechanical (residential) plant(s) for permitting in Louisiana shall be demonstrated upon execution of an appropriate Memorandum of Understanding (MOU), or other, similar contractual instrument, subject to terms and conditions as may be imposed by DHH/OPH—said MOU to be between DHH/OPH and the testing/evaluation facility.

c. Successful completion of testing/evaluation of an individual mechanical (residential) plant in accordance with applicable provisions of this Code, having been properly tested/evaluated and certified by an appropriate facility, shall serve to allow the DHH/OPH authorization of an individual mechanical (residential) plant for permitting purposes in Louisiana for a period not to exceed seven years from the date of such DHH/OPH authorization, or until such time as an appropriate revision to the prevailing testing/evaluation standard for such purposes may become revised. Such authorization of an individual mechanical (residential) plant for permitting purposes in Louisiana shall be in the form of a written license by DHH/OPH to a manufacturer of such individual mechanical (residential) plant(s), subject to compliance with applicable provisions of this Code—such license to be valid for the specified period, annually renewable, and suspendable/revocable by DHH/OPH in accordance with license revocation procedures as specified in §735.F.

2. Licensing

a. In addition to evidence of compliance of an individual mechanical (residential) plant having been properly tested/evaluated and certified by an appropriate facility, certain additional requirements shall serve as a basis for licensing by DHH/OPH of such individual mechanical (residential) plant in Louisiana. These additional requirements shall apply, as appropriate, to the manufacturer and/or manufacturer representative, agent, sub-manufacturer or other associated entity, as appropriate, involved in the manufacture, marketing, sale, installation and/or maintenance of such (any) individual mechanical (residential) plant(s) in Louisiana. Further, with respect to the testing/evaluation facility which may have certified the individual mechanical plants being in compliance with the testing/evaluation standard contained herein,

certain additional requirements, for licensing purposes, shall apply.

b. These additional requirements are specified as follows.

i. Testing/Evaluation Facility Responsibilities

(a). In addition to providing testing/evaluation services with respect to individual mechanical (residential) plants scheduled for manufacture, marketing, sale, installation and maintenance in Louisiana, the testing/evaluation facility shall also serve to provide oversight liaison services both to the manufacturer of the individual mechanical (residential) plant, as well as to DHH/OPH. However, DHH/OPH communication with the testing facility will be at the OPH Program Manager level, or higher. While it is recognized that the testing/evaluation facility may exercise its fiduciary right to exact such fees or other reimbursement costs as appropriate from a manufacturer (client), under no circumstances may the testing/evaluation facility exact such fees or other reimbursement costs from DHH/OPH in order to compensate for any of these regulatory requirements. Accordingly, the following requirements shall be included in the MOU.

(b). It shall be required that all individual mechanical (residential) plant manufacturers will be inspected annually by the testing/evaluation facility having certified the related individual mechanical (residential) plant and that DHH/OPH shall be, upon request, furnished with copies of all reports of such inspections, which shall include at a minimum the verification (or reverification) of all "forms" used in the manufacture (or sub-manufacture) of individual mechanical (residential) plants.

(c). It shall be required that a representative number, up to 4 but in, no case more than 10 percent, of all manufacturers authorized sub-manufacturers of individual mechanical (residential) plants will be inspected annually by the testing/evaluation facility having certified the related individual mechanical (residential) plant and that a report shall be retained by the testing/evaluation facility and shall, upon request by DHH/OPH, make such information available to DHH/OPH, which shall include at a minimum the verification of service records for all related

individual mechanical (residential) plant installations and availability of stand-by parts.

(d). It shall be required that a representative number of installations in Louisiana, but in no case less than 10, of all individual mechanical (residential) plants manufactured by manufacturers and their respective sub-manufacturers will be inspected annually by the testing/evaluation facility having certified the related individual mechanical (residential) plant and that a report shall be retained by the testing/evaluation facility and shall, upon request by DHH/OPH, make such information available to DHH/OPH, which shall include at a minimum the verification (or re-verification) that individual mechanical (residential) plants and their respective installation(s) are in conformity with the plans and specifications as are reflected in the testing/evaluation report which was approved for the related individual mechanical (residential) plant.

(e). It shall be required that copies of all inspection/audit reports conducted by a testing/evaluation facility with regard to a client-related manufacturer (or sub-manufacturer) of individual mechanical (residential) plants will be retained by the testing/evaluation facility and shall, upon request by DHH/OPH, make such information available to DHH/OPH upon completion of said report(s).

(f). It shall be required that copies of all reports of non-compliance and/or reports of complaint(s) investigations by a testing/ evaluation facility with respect to a client-related manufacturer (or sub-manufacturer) of individual mechanical (residential) plant(s) will be retained by the testing/evaluation facility and shall, upon request by DHH/OPH, make such information available to DHH/OPH upon completion of said report(s).

(g). It shall be required that any modification(s) to an individual mechanical (residential) plant, once certified by an ANSI accredited testing/evaluation facility, shall be subject to re-evaluation by the testing/evaluation facility and that written acceptance of the change by the ANSI accredited testing/evaluation facility shall be received by the manufacturer prior to incorporating the change; this information also to be transmitted to DHH/OPH.

(h). In the event that the original testing/evaluation facility no longer conducts testings/evaluations and certifications of individual mechanical (residential) plants for a specific manufacturer, it will be the responsibility of the

testing/evaluation facility to insure an orderly transfer of the documentation supporting certification to the manufacturer for transmittal to another ANSI accredited testing/evaluation facility at the manufacturers choice.

ii. Manufacturer/Sub-Manufacturer Responsibilities

(a). In addition to other, related requirements of this code as pertain to the manufacture, marketing, sale, installation and maintenance of individual mechanical (residential) plant(s) in Louisiana, the manufacturer (or sub-manufacturer, or installer, as appropriate) of an individual mechanical plant shall also be responsible for insuring compliance with the following.

(b). It shall be required that the manufacturer/sub-manufacturer shall annually inspect at least 10 percent of its authorized installers in Louisiana of certified individual mechanical (residential) plants (products) and shall provide written reports of such inspections, which shall minimally address certain matters specified by DHH/OPH, both to the testing/evaluation facility of record as well as to DHH/OPH.

(c). It shall be required that the manufacturer/sub-manufacturer(s) installers of individual mechanical (residential) plant(s) must maintain a current list of all sales/installations of individual mechanical (residential) plants and shall, upon request by DHH/OPH, make such information (i.e., name, address of purchaser, date of sale, etc.) available to DHH/OPH.

(d). It shall be required that manufacturers/sub-manufacturers/installers, as appropriate must provide a minimum two-year service policy to the purchaser of each individual mechanical (residential) plant purchased/ installed at no additional cost, with verification provided to DHH/OPH and the purchaser, of such service policy provision. The initial policy shall contain provisions for four inspection/service visits (scheduled once every six months over the two-year period) during which electrical, mechanical, and other applicable components are inspected, adjusted, and serviced. The initial service policy shall also contain provisions for an effluent quality inspection consisting of a visual assessment of color, turbidity, and scum overflow, and an olfactory assessment for odor.

(e). It shall be required that the manufacturers/sub-manufacturers/installers, as appropriate must make available (subject to the purchaser's right of refusal) an extended service/maintenance agreement with terms comparable to those in the initial service policy, in writing.

(f). The manufacturer/sub-manufacturer shall insure that the individual mechanical (residential) plant and its component parts are properly and easily identified.

(g). The manufacturer/sub-manufacturer shall secure such license(s) as may be required by other, applicable provisions of this code for purpose(s) of manufacture, marketing, sale, installation and/or maintenance of individual mechanical (residential) plant(s) in Louisiana—such license(s) requirement(s) to include, at a minimum as condition of licensure, the verifiable imposition of such insurance, bonding and related requirements as may become stipulated by DHH/OPH for purpose(s) of such related business activities conducted in Louisiana.

(h). Manufacturers shall specifically authorize the ANSI accredited testing/evaluation facility to release to DHH/OPH all of the documentation outlined in terms Subclauses i.(a)-(h) above.

3. Certification

a. Licensing will be based on a two phase certification process, as follows.

i. Initial Certification. Consisting of evidence of successful completion of the herein prescribed testing of an individual mechanical (residential) plant, by the appropriate ANSI accredited testing/evaluation facility conjunctive with an actual onsite physical inspection and audit of all plant manufacturer (company) and sub-manufacturer facilities and production locations by the appropriate ANSI accredited testing facility.

ii. Continuing Certification. Consisting of evidence of an annual re-certification, re-inspection and re-audit by the ANSI accredited testing/evaluation facility of all plant manufacturers (company) and sub-manufacturer facilities and production locations, as well as an evaluation of a representative number (no less than four) of all manufacturers authorized distributors and plants (units/models) sold and installed, with report(s) of such evidence available to DHH/OPH upon request.

G. [Formerly paragraph A:6.7 of Appendix A] Persons proposing to sell individual mechanical plants for installation in Louisiana shall submit an evaluation report

indicating compliance with ANSI/NSF Standard Number 40 and obtain approval from the *Department of Health and Hospitals, Office of Public Health, P.O. Box 60630, New Orleans, LA 70160, prior to selling/installing plants in the state. The compliance evaluation report shall be prepared by an ANSI certified testing laboratory as required in §725.F, and shall include positive identification of all owners, officers, agents, stockholders, contractors, sub-contractors, as may be in any manner or by any means associated with the entity seeking a permit.

1. [Formerly paragraph A.6.7-1 of Appendix A] Upon approval of an evaluation report by the Department of Health and Hospitals, Office of Public Health, the subject individual mechanical plant may be permitted for use in Louisiana. The Office of Public Health will maintain a list of licensed Manufacturers and respective individual mechanical plants permitted for sale/installation in the state.

2. [Formerly paragraph A:6.7-2 of Appendix A] Any alteration or modification of an individual mechanical plant without the certification of the ANSI certified testing laboratory and subsequent approval of DHH-OPH shall constitute a violation of this Section and shall be grounds for suspension/revocation of any permit or license held by each person responsible for such changes, alterations or modifications.

H. [Formerly paragraph A:6.8 of Appendix A] Licenses shall remain valid subject to the following.

1. No person involved with the testing facility either directly or indirectly, may become an owner, partner, or stockholder of any company holding any license to manufacture, submanufacture, install or maintain individual mechanical treatment plants in Louisiana within two years of the approval date of said plant by the Office of Public Health.

2. Should a change of ownership occur, the manufacturer license for such plant shall be rescinded.

3. The licensed Manufacturer shall submit to the Office of Public Health, not later than January 31 of each year, proof that they have secured general liability insurance in an amount of not less than \$1,000,000.

4. The licensed Manufacturer shall be responsible for assuring that their mechanical plants are sold only to licensed submanufacturers and

installers in order to prevent the installation of their plants by unauthorized persons.

I. [Formerly paragraph A:6.8-1 of Appendix A] Persons appealing the denial of their application under the Administrative Procedure Act shall post a cost bond prior to the scheduling of such hearing. The plaintiff shall forfeit the cost bond to the state when said appeal is denied by the hearing officer. The hearing officer is to determine the amount of the cost bond, on a per diem basis. The costs shall include room rental, hearing officer fees, court reporter fees, and transcript costs.

J. [Formerly paragraph A:6.9 of Appendix A] Individual mechanical plants and all components must be installed in compliance with the minimum separation requirements for water wells and appurtenances as required in Part XII of this Code.

K. [Formerly paragraph A:6.9-1 of Appendix A] Individual mechanical plants should be installed at least 10 feet from the property line.

L. [Formerly paragraph A:6.10 of Appendix A] Determination of compliance with NSF Standard Number 40 requirements and/or additional related requirements provided for in this Subchapter shall be the responsibility and sole authority of the state health officer acting through the Office of Public Health.

M. [Formerly Part B paragraph A:6.11 of Appendix A] Warranty/Maintenance/Service Provisions

1. The "Individual Mechanical Plant Initial Warranty Inspection/Service Report" must be submitted to the state health officer after each warranty/maintenance inspection is completed by the maintenance provider, and will become part of the permanent record for each system. A maintenance contract shall be offered to the owner after the initial two-year service contract expires in accordance with National Sanitation Foundation Standard Number 40 relating to Residential Wastewater Treatment Systems, adopted by the Board of Trustees of the National Sanitation Foundation (NSF), Ann Arbor, Michigan, as revised May 1996. The maintenance provider shall notify the state health officer whenever an extended service contract has been negotiated.

2. [Formerly paragraph A:6.12 of Appendix A] The owner is responsible for perpetual maintenance of the sewerage system and components thereof. Proof of perpetual maintenance of the system shall be provided in the form of an extended service contract.

AUTHORITY NOTE: Promulgated in accordance with R.S. 40:4(A)(6) and R.S. 40:5(9)(20).

HISTORICAL NOTE: Promulgated by the Department of Health and Hospitals, Office of Public Health, LR 28:1352 (June 2002).

*Editor's Note: The address cited in §727.C has changed to:
Department of Health and Hospitals
Office of Public Health
Engineering Services Section
P.O. Box 4489
Baton Rouge, LA 70821-4489

§727. Sanitary Pit Privy [formerly Section VII of Appendix A]

A. [Formerly paragraph A:7.1 of Appendix A] Where a dwelling is not served with water under pressure, water carriage waste systems as covered herein can not be used. In these cases, a pit privy or other non water-borne system is required for excreta disposal.

B. [Formerly paragraph A:7.2 of Appendix A] Pit privies, when used, shall be located so that they will not pollute domestic, private, or public water supplies. To accomplish this, they must be located on the downgrade from water wells and water supply lines and in accordance with the minimum distance requirements as contained in Part XII of this Code. Pit privies must be located at least four feet from any fence, ditch or building to give room for a proper earth mound. They must be housed as separate units and must be located at least 10 feet from the property line.

C. [Formerly paragraph A:7.3 of Appendix A] Details of the construction and maintenance of approved pit privies may be obtained by referring to a pamphlet entitled "Louisiana Type Sanitary Pit Privy" which is available through the *Department of Health and Hospitals, Office of Public Health, P.O. Box 60630, New Orleans, LA 70160.

AUTHORITY NOTE: Promulgated in accordance with R.S. 40:4(A)(6) and R.S. 40:5(9)(20).

HISTORICAL NOTE: Promulgated by the Department of Health and Hospitals, Office of Public Health, LR 28:1355 (June 2002).

§729. Pumping Stations [formerly Section VIII of Appendix A]

A. [Formerly paragraph A:8.1 of Appendix A] When the elevation of a site prevents the use of gravity flow to convey liquid from one location to another, a pumping station [§1501.B.19 (Figure 22)], consisting of a holding tank, pump(s), piping, electrical controls, and other equipment as necessary, must be provided.

B. [Formerly paragraph A:8.2 of Appendix A] Many manufacturers build pumps, and in some cases complete pump stations, for the special purpose of handling wastewater, either raw, partially treated, or treated. Such specially built pump stations may be used, provided all other code requirements are met.

C. [Formerly paragraph A:8.3 of Appendix A] Pumps utilized in pump stations must be suitable for the specific application proposed. Pumps must be provided with impellers and casings constructed of corrosion resistant materials.

D. [Formerly paragraph A:8.4 of Appendix A] Pumps shall be provided to accommodate required elevation and hydraulic heads and peak flow rates, and be cycled in a manner not to be unduly disruptive to any downstream system.

E. [Formerly paragraph A:8.5 of Appendix A] The pump station holding tank must be constructed of materials suitable for septic tank use in accordance with §715.I and O of this Subchapter. Additionally, molded fiberglass, reinforced polyester (FRP) resin tanks having a minimum wall thickness of 1/4" are also acceptable.

F. [Formerly paragraph A:8.6 of Appendix A] Holding tanks shall be constructed and installed with suitable foundations to prevent settling due to soil conditions or floating of the tank due to high water table elevations.

G. [Formerly paragraph A:8.7 of Appendix A] Pump station holding tanks shall be constructed and installed so as to be watertight. All wall seams, seams between walls and tank floor, and openings such as for pipes and wiring shall be sealed watertight. Additionally, all holding tank covers and access openings shall be attached in watertight manner by gaskets or grooves and should be sufficiently above the ground, but in no case less than 3 inches above ground, to prevent the entrance of surface runoff water.

H. [Formerly paragraph A:8.8 of Appendix A] The holding tank shall have a minimum diameter or dimension of 24 inches. The cover shall be equipped with an access opening of sufficient size to allow for pump maintenance and removal, but in no case less than 12 inches in diameter or dimension.

I. [Formerly paragraph A:8.9 of Appendix A] Pumps shall be installed in such a manner as to allow for removal and/or maintenance of the pump without necessitating entry into the holding tank by maintenance personnel. Pumps shall be provided with suitable means of quick, convenient disconnection from discharge piping and electrical wiring. Provisions must be made for lifting

the pump from the holding tank with minimal exposure to the liquid in the tank.

J. [Formerly paragraph A:8.10 of Appendix A] Suitable level control devices for use in the harsh, corrosive environment encountered, shall be provided to control pump operation. The level controls shall provide for the following functions: "pump off," "pump on," and "high water alarm."

1. [Formerly paragraph A:8.10-2 of Appendix A] All materials utilized within the holding tank, whether above or below water level, shall be constructed of materials resistant to corrosion from the hostile operating environment of the tank.

2. [Formerly paragraph A:8.10-3 of Appendix A] An audible and visual "high water alarm" shall be provided and shall be located in a conspicuous location. A reset button should be provided for the audible signal in a convenient location so that relief can be easily obtained.

3. [Formerly paragraph A:8.10-4 of Appendix A] The "pump off" level shall be set at the minimum elevation as recommended by the specific pump's manufacturer.

4. [Formerly paragraph A:8.10-5 of Appendix A] The "pump on" level shall be set at elevation to provide a minimum working volume of 10 percent of the average daily design flow of the treatment system.

5. [Formerly paragraph A:8.10-6 of Appendix A] The "high water alarm" level shall be set so as to provide for a net storage volume between the "pump on" level and the "high water alarm level" of 10 percent of the average daily design flow of the treatment system.

6. [Formerly paragraph A:8.10-7 of Appendix A] A reserve volume may be provided between the "high water level" and the invert of the inlet pipe to the holding tank, if so desired.

K. [Formerly paragraph A:8.11-1 of Appendix A] All electrical wiring and controls must be appropriate for the applications for which they are used and meet prevailing electrical codes. Due consideration for the exposure to a harsh environment and the need for watertight connections and conduit must be accounted for in all electrical work.

1. [Formerly paragraph A:8.11-2 of Appendix A] Electrical connections to the main panel in the

house must be made according to prevailing electrical codes.

2. [Formerly paragraph A:8.11-3 of Appendix A] The pump must be wired for automatic level control with a manual override located at the control panel.

L. [Formerly paragraph A:8.12 of Appendix A] Raw sewage pumps and piping must accommodate the passage of 2-inch solids.

M. [Formerly paragraph A:8.13 of Appendix A] Suction and discharge piping for sewage effluent pumps must conform to the pump manufacturer's recommendations. However, piping should not be less than 1.25 inches in diameter and be capable of withstanding a pressure of 75 psi.

AUTHORITY NOTE: Promulgated in accordance with R.S. 40:4(A)(6) and R.S. 40:5(9)(20).

HISTORICAL NOTE: Promulgated by the Department of Health and Hospitals, Office of Public Health, LR 28:1355 (June 2002).

§731. Effluent Reduction System Requirements for Treated Wastewater [formerly Section IX of Appendix A]

A. [Formerly paragraph A:9.1 of Appendix A] Disinfectants. Where effluent discharges are required to be disinfected, and chlorine is used as the disinfectant, a chlorine contact chamber is required. Calcium hypochlorite, labeled for wastewater disinfection, shall be added in sufficient concentrations to maintain a minimum residual of 0.5 ppm total chlorine in the effluent. In order to achieve the required chlorine contact time, a baffled chlorine contact chamber [§1501.B.11 (Figures 11, 12, 13)] designed to meet the needs for each system with the specified liquid holding capacity shall be used as follows.

| Disinfectant Chamber Minimum Liquid Capacity | |
|--|---------------------------------|
| Treatment Capacity of Sewerage System | Contact Chamber Liquid Capacity |
| 500 GPD or less | 30 gallons |
| 501-750 GPD | 45 gallons |
| 751-1000 GPD | 60 gallons |
| 1001-1500 GPD | 90 gallons |

1. Any other disinfectant proposed for use should provide an equivalent level of disinfection.

B. [Formerly paragraph A:9.2 of Appendix A] Pumping Stations. Pumping station, when required, must be constructed of approved materials, and must comply with the applicable provisions of this Code.

C. [Formerly paragraph A:9.3 of Appendix A] Effluent Reduction Systems. Individual sewage systems, with a

capacity up to and including 1500 gpd, that produce a treated, off-site effluent, shall include an effluent reducer as part of the overall system [§1501.B.12 (Figure 14)].

D. [Formerly paragraph A:9.4 of Appendix A] Special situations may arise where an individual on-site wastewater treatment system is allowed as per §511.B of this Code, but it is physically impossible to install the required size of the effluent reduction system or the effluent reduction system itself due to lot size or when a limited use sewerage system is installed in a marsh/swamp area or located over water. The size of the effluent reduction system can be reduced to the maximum amount the lot can accommodate or the installation waived with the authorization of the sanitarian parish manager. Written notification of such authorization must be submitted to the sanitarian regional director and a copy attached to the "Application for Permit for Installation of On-Site Wastewater Disposal System" (LHS-47).

E. [Formerly paragraph A:9.5 of Appendix A] All effluent reduction systems shall be installed by a licensed installer. Existing field lines can not be used as the effluent reduction system.

F. [Formerly paragraph A:9.6 of Appendix A] The size of the effluent reduction system installed has to correspond with the recommended size of the sewerage system. For example if a 750 GPD plant is required on the "Application For Permit For Installation of On-Site Wastewater Disposal System" (LHS-47), the applicant may install a 1000 GPD plant, however the size of the effluent reduction system only has to correspond to the minimum size required for a 750 GPD plant.

G. [Formerly paragraph A:9.7 of Appendix A] The sample port for a sewerage system must be installed immediately downstream of the system and in accordance with the appropriate edition and Section of NSF Standard 40, as currently promulgated, as well as the applicable provisions of this Code.

AUTHORITY NOTE: Promulgated in accordance with R.S. 40:4(A)(6), R.S. 40:5(9)(20), and R.S. 40:1154(A).

HISTORICAL NOTE: Promulgated by the Department of Health and Hospitals, Office of Public Health, LR 28:1356 (June 2002).

§733. Effluent Reduction Options
[formerly Section IX of Appendix A]

A. [Formerly paragraph A:9.8-1 of Appendix A] Effluent Reduction Field. This system is installed downstream of a mechanical treatment plant or other sewage treatment system listed in Chapter 7 Subchapter B of this Code that produces an effluent, but does not by design significantly reduce that effluent. The effluent reduction field is essentially a soil absorption field as described in §719 of this Subchapter, but with modification as noted in this Section. Section 1501.B.13 (Figure 15) has a diagram with specifications and cross-sections of the effluent reduction field.

1. [Formerly paragraph A:9.8-2 of Appendix A] If there is not sufficient grade to install the sewerage system and the effluent reduction field with gravity flow to the discharge point, then a pump station in compliance with applicable provision of this code must be installed.

2. [Formerly paragraph A:9.8-3 of Appendix A] The force of the pumped effluent must be reduced by use of a distribution box, "Tee," or similar appurtenance.

3. [Formerly paragraph A:9.8-4 of Appendix A] The effluent reduction field trenches shall be at least 18 inches wide and between 16 to 24 inches in depth.

4. [Formerly paragraph A:9.8-5 of Appendix A] The bottom of the effluent reduction field must be level.

5. [Formerly paragraph A:9.8-6 of Appendix A] The fill or cover material shall be of porous soil or sand which allows the passage of water in all directions, with sod started on top. Fill should be at least 4 to 6 inches above grade and spread at least 3 to 4 feet on either side of the trench.

6. [Formerly paragraph A:9.8-7 of Appendix A] The effluent reduction field (ERF) must be installed a minimum of 10 feet from any property line. In addition the ERF field location shall comply with the minimum distance requirements from water wells and suction lines, water pressure lines, etc., as contained in Parts XII and XIV of this Code.

7. [Formerly paragraph A:9.8-8 of Appendix A] The minimum length of the effluent reduction field shall be determined by the treatment capacity of the sewerage system.

| Treatment Capacity of Sewerage System | Minimum Total Length per Field |
|---------------------------------------|--------------------------------|
| 500 GPD or less | 100 ft |
| 501-750 GPD | 150 ft |

| | |
|---------------|--------|
| 751-1000 GPD | 200 ft |
| 1001-1500 GPD | 300 ft |

8. [Formerly paragraph A:9.8-9 of Appendix A] If more than one absorption trench is used to provide the minimum required length of the effluent reduction field, the distance between individual trenches must be at least 6 feet with one discharge pipe provided.

9. [Formerly paragraph A:9.8-10 of Appendix A] The pipe from the end of the effluent reduction field to the discharge point must be solid.

10. [Formerly paragraph A:9.8-11 of Appendix A] A backwater valve must be provided at the end of the effluent reduction field whenever the discharge line is less than 12 inches above the ditch flow-line.

11. [Formerly paragraph A:9.8-12 of Appendix A] Each individual trench must not be greater than 100 feet in length. Clam or oyster shells may be substituted for gravel in the effluent reduction field. If used, gravel must be clean, graded and 1/2-inch to 2 1/2 inches in diameter. Other media may be considered for use if determined to have acceptable characteristics and properties. Although it may not be noted in the attached figures (§1501.B.1-19), the end of the discharge line must have a 1/2 diameter PVC end cap over the lower half of the endpipe, causing longer retention of the effluent and providing greater opportunity for absorption. If the end of the discharge line is more than 2 inches lower than the absorption line, other provisions must be made to cause the effluent to be retained in the reduction field.

12. [Formerly paragraph A:9.8-13 of Appendix A] Gravelless pipe or other distribution chambers may be used in lieu of conventional soil absorption pipe. If gravelless pipe is used, the fill must be porous soil or sand which allows the passage of water in all directions, with a 6-inch layer below the pipe and filled 4 to 6 inches above grade and spread 3 to 4 feet on either side of the trench.

B. [Formerly A:9.9-1 of Appendix A] Rock-Plant Filter. All rock plant filters must be a minimum of 5 feet wide to a maximum of 10 feet wide.

1. [Formerly paragraph A:9.9-2 of Appendix A] The square footage will be determined by the treatment capacity of the sewerage system as follows.

| Treatment Capacity of Sewerage System | Rock Plant Filter Size |
|---------------------------------------|------------------------|
| 500 GPD or less | 150 square feet |
| 501-750 GPD | 225 square feet |
| 751-1000 GPD | 300 square feet |
| 1001-1500 GPD | 450 square feet |

a. Refer to §1501.B.14 (Figures 16 and 17) for a schematic and cross section of a rock plant filter with a sewerage system installation.

2. [Formerly paragraph A:9.9-3 of Appendix A] The rock plant filter (RPF) must be installed a minimum of 10 feet from any property line. In addition, the RPF location shall comply with the minimum distance requirements from water wells and suction lines, water pressure lines, etc., as contained in Parts XII and XIV of this Code.

3. [Formerly paragraph A:9.9-4 of Appendix A] If there is not sufficient grade to install the sewerage system and the rock plant filter with gravity flow to the discharge point, then a pumping station in compliance with applicable provisions of this Part must be installed.

4. [Formerly paragraph A:9.9-5 of Appendix A] In order to prevent backflow, a backwater valve is required whenever the discharge line is less than 12 inches above the ditch flow-line.

5. [Formerly paragraph A:9.9-6 of Appendix A] Only a standard shape bed may be installed with a minimum width of 5 feet and of such length as to provide the required square footage.

6. [Formerly paragraph A:9.9-7 of Appendix A] Plans for any other configuration must be submitted for review and approval to the sanitarian regional director.

7. [Formerly paragraph A:9.9-8 of Appendix A] A liner will be required when the ground water level is within 24 inches of the bottom of the trench.

8. [Formerly paragraph A:9.9-9 of Appendix A] The polyethylene liner may be of more than one layer provided a total thickness of 16 mil is achieved.

9. [Formerly paragraph A:9.9-10 of Appendix A] When a liner is not required, the use of landscape fabric is highly recommended to prevent weed intrusion.

10. [Formerly paragraph A:9.9-11 of Appendix A] The bottom of the bed must be level and be no deeper than 14 inches.

11. [Formerly paragraph A:9.9-12 of Appendix A] A depth of approximately 10 to 12 inches is best.

12. [Formerly paragraph A:9.9-13 of Appendix A] Gravel must be 2-3 inches in diameter and laid to a depth of 12 inches.

13. [Formerly paragraph A:9.9-14 of Appendix A] An 8-inch water level must be maintained. Gravel should fill the filter bed to above surface grade to prevent erosion.

14. [Formerly paragraph A:9.9-15 of Appendix A] The minimum 4-inch perforated inlet pipe must be located no closer than 4 inches from the bottom of the bed and supported by a footing of noncorrosive material, such as concrete or treated timber.

15. [Formerly paragraph A:9.9-16 of Appendix A] The inlet should extend no more than 2 feet into the rock plant bed and must be provided with a "Tee" (with ends capped) extending the width of the bed to within 1 foot of the side walls.

16. [Formerly paragraph A:9.9-17 of Appendix A] The outlet pipe shall also be set in a footing of noncorrosive material (concrete or treated timber) on the bottom of the bed with the same "Tee" and configuration. The outlet must be elbowed up and out [§1501.B.14 (Figure 17)].

17. [Formerly paragraph A:9.9-18 of Appendix A] Do not allow plants to grow within 3 feet of the inlet and outlet of the bed.

18. [Formerly paragraph A:9.9-19 of Appendix A] A levee support system around the perimeter of the filter should be constructed to exclude surface water. The use of landscape timbers for this purpose is acceptable. Other materials, such as concrete, can also be used.

C. [Formerly paragraph A:9.10-1 of Appendix A] Spray Irrigation. The spray irrigation system [§1501.B.15 (Figure 18)] uses an electric pump that distributes the effluent to the yard through sprinkler heads. It is highly recommended for spray irrigation effluent to be chlorinated in a contact chamber, sized according to §731.A, following the treatment unit and preceding discharge. At a predetermined level, a float switch activates a pump that forces the effluent through piping to pop-up or elevated rotating type sprinkler heads. Evaporation and soil infiltration of the dispersed effluent should prevent any run-off from occurring.

1. [Formerly paragraph A:9.10-2 of Appendix A] A pump station system must be sized according to use and comply with the applicable provisions of this Part.

2. [Formerly paragraph A:9.10-3 of Appendix A] The pressure pump must be a minimum of one-half horse power capable of producing a minimum flow of 12 gallons per minute and maintaining 25 pounds per square inch at all sprinkler heads.

3. [Formerly paragraph A:9.10-4 of Appendix A] The pump will be activated by a high/low water switch through an automatic on/off switch. The pump must be deactivated through a low-volume cut off switch.

4. [Formerly paragraph A:9.10-5 of Appendix A] A time cycle device may be used to allow for specific sprinkling times (e.g., nighttime, afternoon). The pump chamber must be of adequate liquid capacity to allow sufficient storage to accommodate the desired time settings.

5. [Formerly paragraph A:9.10-6 of Appendix A] A minimum of three 4-inch type sprinkler heads coded for wastewater effluent, spaced a minimum of 40 feet apart are required.

6. [Formerly paragraph A:9.10-7 of Appendix A] The spray irrigation sprinklers shall comply with American Society of Agricultural Engineers (ASAE) Standard S 398.1 (Procedure for Sprinkler Testing and Performance Reporting).

7. [Formerly paragraph A:9.10-8 of Appendix A] The slope of the land shall be such as to facilitate drainage away from any water well or well suction lines. The edge of the spray and its drainage must be a minimum of 50 feet from any private water well and its associated suction lines and 10 feet from any property line. The edge of the spray and its drainage shall be a minimum 100 foot from public any water supply well and its associated suction lines, if any. In addition, the edge of the spray and its drainage shall be a minimum of 25 feet from any potable water (pressure) lines. As contained in Parts XII and XIV of this Code.

8. [Formerly paragraph A:9.10-9 of Appendix A] Exceptions due to lot size, topography or other constraints may be authorized by the sanitarian parish manager with written notification of such authorization to the sanitarian regional director and a copy attached to the LHS-47.

D. [Formerly paragraph A:9.11-1 of Appendix A] Overland Flow. When the size of the property is 3 acres

or more, an overland flow may be utilized [§1501.B.16 (Figure 19)].

1. [Formerly A:9.11-2 of Appendix A] The discharge through perforated pipe must be distributed in such a manner as to confine the effluent on the property owned by the generator.

2. [Formerly A:9.11-3 of Appendix A] The location of the overland discharge must have a permanent vegetative cover.

3. [Formerly A:9.11-4 of Appendix A] The slope of the land shall be such as to facilitate drainage away from any water well or well suction lines. The discharge point and the field of flow shall be a minimum of 50 feet from any private water well and its associated suction lines. The discharge point and the field of flow shall be a minimum 100 foot from public water supply wells and its associated suction lines, if any. In addition, the discharge point and the field of flow shall be a minimum of 25 feet from any potable water (pressure) lines. As contained in Parts XII and XIV of this Code.

4. [Formerly A:9.11-5 of Appendix A] A header should be used at the end of the discharge line to help disperse the effluent and to discourage channelization. The point of discharge must be such that there is at least a 200 foot flow of effluent over the property of the generator.

5. [Formerly A:9.11-6 of Appendix A] Construction of the system should be such that it is not closer than 20 feet from the property line.

E. [Formerly A:9.12 of Appendix A] Mound System or Subsurface Drip Disposal [§1501.B.17 and 18 (Figures 20 and 21)]. Either can be considered by DHH-OPH on a case to case basis. Plans and specifications must be submitted to DHH-OPH engineering services in consultation with the sanitarian regional director for review and approval prior to construction.

AUTHORITY NOTE: Promulgated in accordance with R.S. 40:4(A)(6) and R.S. 40:5(9)(20).

HISTORICAL NOTE: Promulgated by the Department of Health and Hospitals, Office of Public Health, LR 28:1357 (June 2002).

**Subchapter C. Licensing Procedures for
Installers
and Manufacturers of Individual
Sewerage Systems
[formerly Chapter 13 Subpart F]**

**§735. General Procedures
[formerly paragraph 13:022-1]**

A. **Manufacturer License.** A person who wishes to engage in the business or practice of constructing an individual mechanical sewerage treatment system, and who is responsible for having the system evaluated in compliance with §725.F of this Part, shall first obtain a license for each approved tested design of plant manufactured, from the state health officer.

B. [Formerly paragraph 13:022-2] **Installer License.** A person who wishes to perform installations or maintenance of individual sewerage systems shall first obtain the appropriate type of individual sewerage installer license. Two types of licenses are offered:

1. a basic license for installation and maintenance of facilities other than individual mechanical plants; and

2. a combination license which allows the installation and maintenance of individual mechanical plants as well. A combination license may be obtained only in conjunction with a basic license, and is considered to be a separate license.

C. [Formerly paragraph 13:022-3] **Sub-Manufacturer License.** A person or entity authorized by a licensed manufacturer to construct, or assemble individual sewerage systems, or any portion thereof, prior to offering such systems for installation in Louisiana, is required to obtain an individual sewerage system sub-manufacturer license.

D. [Formerly paragraph 13:022-4] **Application.** Applications for an Individual Sewerage System Installer and/or Maintenance Provider License, as well as for Individual Sewerage System Sub-Manufacturer License, may be obtained from the nearest Parish Health Unit. Applications, including any required endorsements or certifications, must be submitted to the Sanitarian Program Administrator—Individual Sewage, Sanitarian Services Section, Office of Public Health. All licenses shall be issued by this office upon successful fulfillment of all application requirements and completion of any required examination(s), and shall be valid throughout the entire state.

E. [Formerly paragraph 13:022-5] **Renewal.** All licenses expire on January 31 of each year. Applications for renewal including all required endorsements must be received no later than December 1 of each year in order to insure timely renewal. The renewal of a license will be withheld from any applicant who has not complied with the requirements of this Part.

F. [Formerly paragraph 13:022-6] **Suspension or Revocation of License.** In addition to other remedies provided for by law, a license may be suspended upon determination by the state health officer of non-compliance with the requirements of this code. In the event of suspension, notice shall be given to the licensee having committed said violation(s) that his license has been suspended pending an Administrative Hearing in the matter to determine whether sufficient grounds for revocation exist.

G. [Formerly paragraph 13:022-7] **Reinstatement of License.** Upon revocation of a license, an installer, maintenance provider, manufacturer, or submanufacturer shall not be eligible for any license for a minimum period of two years from the date of revocation for cause.

AUTHORITY NOTE: Promulgated in accordance with R.S. 40:4(A)(6) and R.S. 40:5(9)(20).

HISTORICAL NOTE: Promulgated by the Department of Health and Hospitals, Office of Public Health, LR 28:1359 (June 2002).

§737. Installer/Maintenance Provider Qualifications

A. For a basic license, the applicant shall submit, along with the license application and evidence of successful completion of an examination, an affidavit certifying that he has obtained, read, and understands the provisions of this Part of the Sanitary Code, including Chapter 7 Subchapter B of this Part, and the requirements for minimum distance to sources of contamination in Part XII and will make installations and/or provide maintenance in compliance therewith. Copies of a standard affidavit form and request for examination form may be obtained from any parish health unit.

B. For a combination license, the applicant shall submit, along with the license application and evidence of successful completion of an examination, an endorsement from the licensed manufacturer for the brand of plant he wishes to install and/or maintain, specifying that the applicant is qualified to install and/or maintain said plants, in compliance with the requirements of this Code.

Applications will not be processed unless accompanied by the required endorsement.

C. For a maintenance license, the applicant shall submit the license application and evidence of successful completion of an examination, an endorsement from the licensed manufacturer for the brands of plants he wishes to maintain, specifying that the applicant is qualified to maintain said plants, in compliance with the requirements of this Code. Licensed manufacturers shall issue such endorsements to any and all individuals who present themselves for training and who meet the manufacturer's minimum standards for competency.

D. All persons seeking to apply for a new license or renewal must, at their own expense, attend and successfully complete a training course approved by the Sanitarian Services Section of the Office of Public Health, Department of Health and Hospitals, as a prerequisite for licensure. This course will be offered at least once annually.

E. All licensees must successfully repeat this training course every five years.

F. A listing of training course dates, times, and locations shall be maintained in the various regional offices by the sanitarian regional directors.

G. In the event an approved training course is not available within 60 days, the sanitarian services section may issue a temporary license provided the applicant meets all of the other requirements cited in this Section and successfully completes an examination administered by the sanitarian regional director. This temporary license shall terminate upon failure to attend the next available approved training course. Applicants who fail to attend the required training course shall not be issued another temporary license, but may reapply for a license upon successful completion of the required training course.

H. Applicants for an installer's, combination, or maintenance license shall submit, along with the license application, proof that they have secured, for at least the duration of the license, general liability insurance in an amount of no less than \$100,000/\$300,000.

AUTHORITY NOTE: Promulgated in accordance with R.S. 40:4(A)(6) and R.S. 40:5(9)(20).

HISTORICAL NOTE: Promulgated by the Department of Health and Hospitals, Office of Public Health, LR 28:1359 (June 2002), amended by the 2005 Regular Session, House Concurrent Resolution No. 1, LR 31:1914 (July 2005).

§739. Sub-Manufacturer Qualifications [formerly paragraph 13:023-2]

A. Applicants for a Sub-Manufacturer License shall submit, along with the license application, an endorsement from the manufacturer(s) for the brand(s) of plant(s) he wishes to construct, certifying that he is qualified to construct said plant(s) properly and in accordance with the requirements of this Code. Applications will not be processed unless accompanied by the required endorsement(s).

B. Applicants for a Sub-Manufacturer License shall submit, along with the license application, proof that they have secured, for at least the duration of the license, general liability insurance in an amount of no less than \$100,000/\$300,000.

AUTHORITY NOTE: Promulgated in accordance with R.S. 40:4(A)(6) and R.S. 40:5(9)(20).

HISTORICAL NOTE: Promulgated by the Department of Health and Hospitals, Office of Public Health, LR 28:1360 (June 2002).

§741. Manufacturer Qualifications [formerly paragraph 13:023-3]

A. All licensed manufacturers must be in compliance with the requirements of §725.

AUTHORITY NOTE: Promulgated in accordance with R.S. 40:4(A)(6) and R.S. 40:5(9)(20).

HISTORICAL NOTE: Promulgated by the Department of Health and Hospitals, Office of Public Health, LR 28:1360 (June 2002).

Chapter 9. Sewage Hauling

§901. General Requirements [formerly paragraph 13:019-1]

A. A person shall not engage in the business or practice of hauling the contents of septic tanks, cesspools, vaults, or similar facilities without first obtaining a license from the state health officer. Applications for a license to haul sewage may be obtained from the nearest parish health unit. Applications must be sent to the Sanitarian Program Administrator—Individual Sewage, Sanitarian Services Section. All licenses shall be issued by this office and shall be valid throughout the state.

B. [Formerly paragraph 13:019-2] All licenses expire on June 30 of each new year. Applications for renewal must be received no later than May 1 of each year in order to insure timely renewal. Initial applications received between July 1 and March 30 will receive a license for that fiscal year (July 1

through June 30); those initial applications received after March 30 will receive a license for the remainder of that fiscal year in addition to the next fiscal year.

C. [Formerly paragraph 13:019-3] Upon determination by the state health officer of substantial non-compliance with the requirements of this code with respect to the hauling and/or disposing of the contents of septic tanks, cesspools, vaults, or similar facilities, (not including grease traps), written notice, in compliance with R.S. 49:961, shall be given to the licensee having made said violations that he shall, within 15 working days, present to the notifying office any and all evidence to show compliance with the requirements for retention of the license. In the absence of such evidence, the licensee shall be further notified that his license has been temporarily suspended pending a hearing in the matter to consider whether sufficient grounds for revocation of the license exist. The licensee shall be notified, in writing, of the date of the hearing within seven working days from the date of the notice of suspension. The date for such hearing shall be within 45 working days of the notice of suspension.

D. [Formerly paragraph 13:019-4] Upon revocation of a license, a hauler shall not be eligible to reapply for the same license for a period of two years from the date of revocation for cause.

E. [Formerly paragraph 13:019-5] Disposal of the contents of septic tanks, cesspools, vaults, or similar facilities shall be made in accordance with the arrangements, approved in the permit, for disposal at an approved sewage treatment facility. As a prerequisite to obtaining a license, evidence for such arrangements, including copies of any agreements with cooperating sewage treatment facilities, shall be submitted. The disposal of the contents of septic tanks, cesspools, vaults, or similar facilities into ditches, canals, rivers, lakes, pits, or other surface water courses is prohibited.

F. [Formerly paragraph 13:019-6] No person shall convey or cause to be conveyed through the streets, roads, or public waterways any contents from a septic tank, vault, cesspool, or privy, except in tight enclosed containers, so as not to be offensive to smell or injurious to health.

AUTHORITY NOTE: Promulgated in accordance with R.S. 40:4(A)(6) and R.S. 40:5(9)(20).

HISTORICAL NOTE: Promulgated by the Department of Health and Hospitals, Office of Public Health, LR 28:1360 (June 2002).

Chapter 11. Non-Waterborne Systems

§1101. General Requirements [formerly paragraph 13:020-1]

A. Non-waterborne systems, such as a pit toilet (or privy), vault, pail, or chemical toilet, incinerator toilet or composting toilet may be used when the state health officer determines that it is impractical or undesirable, i.e., such as water under pressure is not available, either to connect to an existing community-type sewerage system as specified in §511.A or to construct or install a conventional septic tank system or individual mechanical plant and when in the opinion of the state health officer a non-waterborne system will function without creating a health hazard or nuisance.

B. [Formerly paragraph 13:020-2] Non-waterborne systems shall be located a safe distance from any well, spring or other source of water supply and, if possible, upon ground at a lower elevation. Such distances shall conform to the requirements of Part XII of this Code. In soil types or geological formations where sources of water supplies may be polluted, the state health officer may require the use of chemical toilets or concrete vaults in lieu of pit toilets.

C. [Formerly paragraph 13:020-3] Non-waterborne systems shall be properly maintained and operated. The following shall be considered defects in maintenance and operation of such installations:

1. evidence of caving around the edges of the pit;
2. signs of overflow or other evidence that the pit, vault, or pail is full;
3. evidence of light entering the pit except through the seat when the seat cover is raised;
4. seat cover not in place;
5. broken, perforated, or unscreened vent pipes;
6. uncleanliness of any kind in the toilet building.

AUTHORITY NOTE: Promulgated in accordance with R.S. 40:4(A)(6) and R.S. 40:5(9)(20).

HISTORICAL NOTE: Promulgated by the Department of Health and Hospitals, Office of Public Health, LR 28:1361 (June 2002).

Chapter 13. Special Applications [formerly Chapter 13 Subpart E]

§1301. General Requirements [formerly paragraph 13:021]

A. A number of unique or special situations pose certain problems with respect to sewage disposal. These atypical cases are dealt with as follows.

1. Apartment complexes, condominium complexes, hotels, motels, and other such complexes shall be connected to a community sewerage system. A commercial treatment facility shall be provided when no existing community sewerage system capable of accepting the additional loading exists.

2. Single commercial structures, where less than 1,500 gpd total flow is expected, and where the connection to a community sewerage system to serve other loading sources as well is not required, may utilize either an individual or commercial sewerage system, provided minimum lot size requirements for the use of individual sewerage systems are met.

a. A commercial treatment facility shall be installed for business establishments where the preparation of food and/or drink is the primary business activity.

3. Treatment facilities for very small trailer parks which contain five trailer spaces or less shall be sized at 400 gallons per day per trailer space.

4. Where a community sewerage system is not available, structures occupied three days per week or less, and located in a marsh/swamp area or over water, may utilize a limited use sewerage system comprised of the following:

a. a septic tank system consisting of three septic tanks in series (or an acceptable three-cell or three-compartment tank) followed by an automatic chlorination device/system. The first cell shall have a minimum liquid capacity of 500 gallons. The second and

third cells shall each have a minimum liquid capacity of 250 gallons. Each of the three septic tanks (or each compartment of a three-cell tank) shall meet all design, material and construction requirements for septic tanks as described in §715 of this Part. In addition to the construction and material requirements in Chapter 7, Subchapter B, the following restrictions/exceptions shall also apply:

- i. metal tanks shall not be used;
- ii. the tank(s) shall be demonstrated to be water-tight;
- iii. fiberglass tanks shall be adequately coated to prevent deterioration by ultraviolet light;
- iv. where multiple-compartment single tanks are used, only one access opening, of 6-inch minimum diameter, per cell shall be required; and
- v. tanks set below the normal high-water level, shall be anchored or otherwise secured against movement;
- vi. the chlorination system shall be provided with a contact chamber of a minimum of 100 gallons, and shall be equipped with an automatic cutoff to prevent flow from the third septic tank/chamber if the chlorine supply is exhausted. Also, the effluent line from the chlorine contact tank shall be protected against entrance of small animals or other pests by use of a corrosion-resistant flap-type gate, screen, or other means approved by the state health officer.

5. Vessels. Vessels which are permanently moored shall be connected to an approved sewerage system.

AUTHORITY NOTE: Promulgated in accordance with R.S. 40:4(A)(6) and R.S. 40:5(9)(20).

HISTORICAL NOTE: Promulgated by the Department of Health and Hospitals, Office of Public Health, LR 28:1361 (June 2002).

Chapter 15. Sewage Loading Criteria [formerly Chapter 13 Appendix B]

§1501. General Requirements

A. See Note (a)

| Place | Loading | Daily Average Flow Gallons per Day | Daily Average BOD ₅ Pounds per Day | Design Basis |
|--|----------|---------------------------------------|--|--|
| Apartments | | 250 | 0.425 | one bedroom |
| | | 300 | 0.52 | two bedroom |
| | | 400 | 0.68 | three bedroom |
| Assembly | Note (b) | 2 | 0.0034 | per seat |
| Bowling Alleys (no food service) | Note (b) | 75 | 0.13 | per lane |
| Churches | Note (b) | 5 | 0.0088 | per sanctuary seat |
| Churches (with permitted kitchens) | Note (c) | 10 | 0.017 | per sanctuary seat |
| Country Clubs | | 50 | 0.085 | per member |
| Dance Halls | Note (b) | 2 | 0.0034 | per person |
| Drive-In Theaters | | 5 | 0.0085 | per car space |
| Factories (no showers) | | 20 | 0.051 | per employee |
| Factories (with showers) | | 35 | 0.06 | per employee |
| Food Service Operations | | | | |
| Ordinary Restaurant (not 24 hour) | | 35 | 0.12 | per seat |
| 24-hour Restaurant | | 50 | 0.17 | per seat |
| Banquet Rooms | | 5 | 0.017 | per seat |
| Restaurant Along Freeway | | 100 | 0.33 | per seat |
| Curb Service (drive-in) | | 50 | 0.17 | per car space |
| Bar, Cocktail Lounges, Taverns | | | | |
| (no food service or very little food service) | | 25 | 0.084 | per seat |
| (with regular food service) | | 35 | 0.12 | per seat |
| Video Poker Machine | | 100 | 0.20 | per machine |
| Fast Food Restaurants | | 40 | 0.13 | per seat |
| Hotel/Motel Food Service | | 45 | 0.17 | per room |
| Homes/Mobile Homes in Subdivisions | | 400 | 0.68 | per dwelling |
| Individual Homes/Mobile Homes (where individual sewage technology is utilized. For each additional bedroom add 100 gpd) | | 250 | 0.425 | one bedroom |
| | | 300 | 0.51 | two bedrooms |
| | | 400 | 0.68 | three bedrooms |
| Hospitals (no resident personnel) | Note (c) | 200 | 0.51 | per bed |
| Institutions (residents) | Note (c) | 100 | 0.25 | per person |
| Municipalities | | 100 | 0.17 | per person |
| Mobile Home Parks | | | | |
| up to 5 trailer spaces | | 400 | 0.68 | per mobile home space |
| 6 trailer spaces or more | | 300 | 0.51 | per mobile home space |
| Motels | Note (b) | 100 | 0.12 | per unit |
| Nursing and Rest Homes | Note (c) | 100 | 0.25 | per patient |
| | | 100 | 0.17 | per resident employee |
| Office Buildings | | 20 | 0.051 | per employee |
| Recreational Vehicle Dumping Stations | | | | Consult OPH |
| Recreational Vehicle Parks and Camps | | 125 | 0.21 | per trailer or tent space |
| Retail Store | | 20 | 0.034 | per employee |
| Schools Elementary | Note (c) | 15 | 0.038 | per pupil |
| Schools High and Junior High | Note (c) | 20 | 0.051 | per pupil |
| Retail Fuel Stations (Located on major highways, etc., and whose primary function is to provide fuel and service to motor vehicles) | Note (d) | 250 | 0.43 | per individual vehicle fueling point (up to the first four) |
| | | 125 | 0.21 | for each additional individual vehicle fueling point |
| Shopping Centers (no food service or laundries) | | 0.2 | 0.00034 | per square foot of floor space |

| Place | Loading | Daily Average Flow Gallons per Day | Daily Average BOD ₅ Pounds per Day | Design Basis |
|-------------------------------------|----------|---------------------------------------|--|--------------|
| Swimming Pool (including employees) | | 10 | 0.017 | per swimmer |
| Showers | | 20 | 0.04 | per shower |
| Vacation Cottages | | 50 | 0.12 | per person |
| Youth and Recreation Camps | Note (c) | 50 | 0.12 | per person |
| Washing Machines | | 400 | 1.34 | per machine |

- Note (a) If loading criteria other than presented here are used, they should be justified.
- Note (b) Food Service waste not included.
- Note (c) Food Service waste included but without garbage grinders.
- Note (d) Vehicle fueling points are an arrangement of gasoline or diesel fuel pumps to serve automobiles or other vehicles. For the purposes of these guidelines, a vehicle fueling point is one that serves a vehicle at one time. Food service waste not included.

Note: Design calculations for sewage treatment facilities must be made based on both hydraulic loading(s) and organic loading(s). Final design of facility to be used upon the larger capacity (size) required by these calculations.

B. Figures

1. Methods of Making Percolation Tests

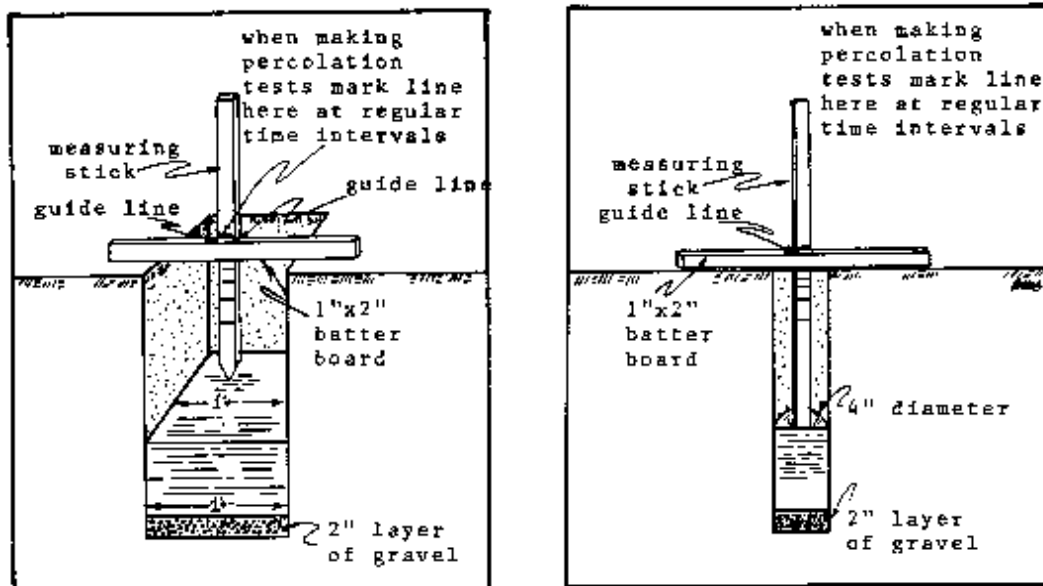

- NOTE: 1. Leave batter board in place, being careful not to move it during tests.
2. Keep measuring stick within guide lines on batter board when each reading is taken.

FIGURE 1
METHODS OF MAKING PERCOLATION TESTS

2. Typical Layout of Absorption Trench

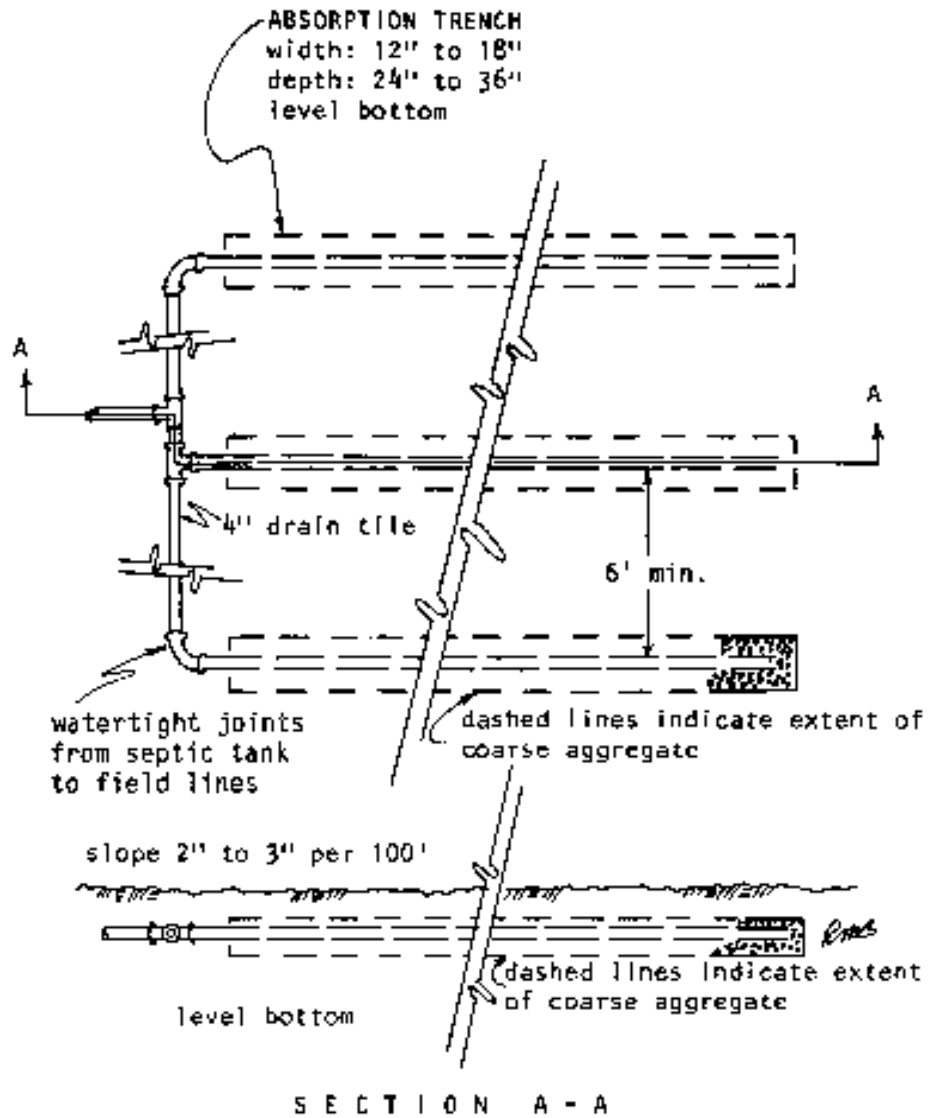

NOTE: See Figure 4 for additional details

FIGURE 2
TYPICAL LAYOUT OF ABSORPTION TRENCH

3. Absorption Field System for Sloping Ground

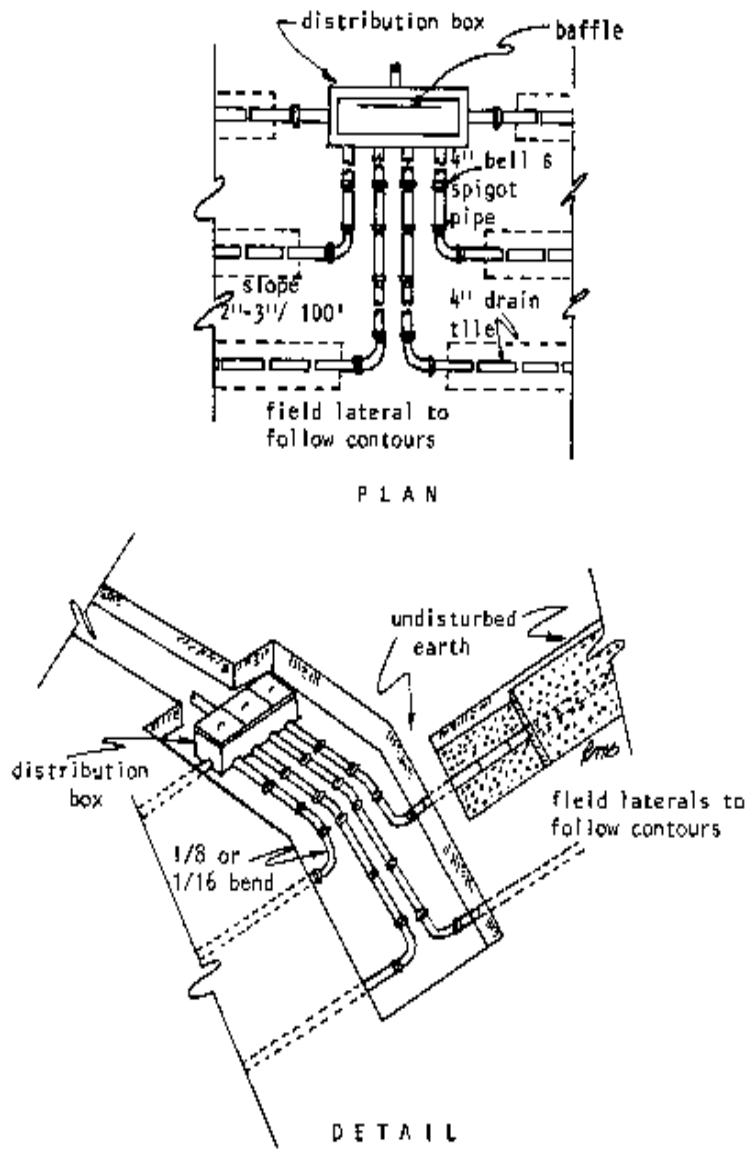

NOTE: See Figure 4 for additional details

FIGURE 3
ABSORPTION FIELD SYSTEM FOR SLOPING GROUND

4. Absorption Trench and Lateral Details

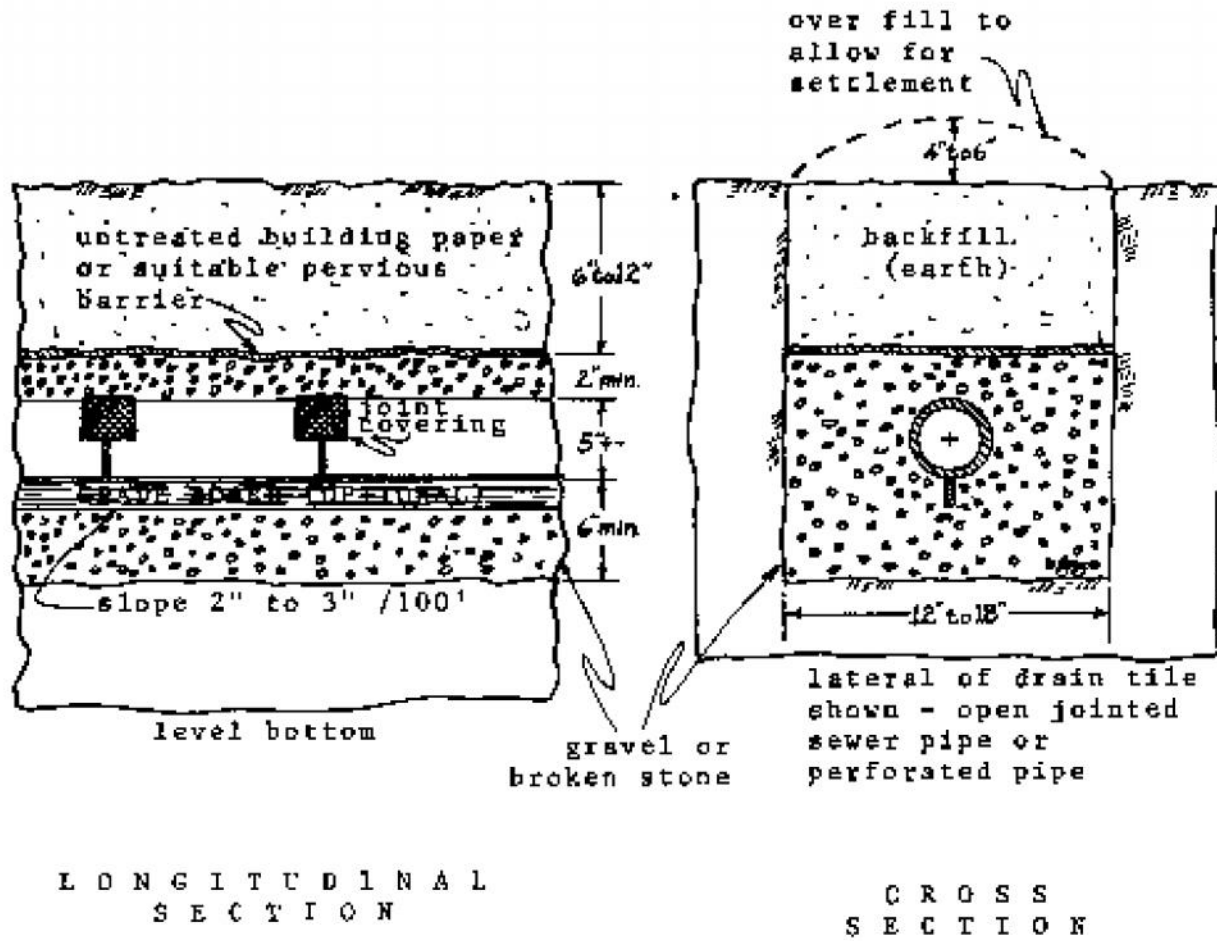

- NOTES: 1. Drain tile laid with joints opened from $\frac{1}{4}$ to $\frac{1}{2}$ inch. Special collars may be used if desired.
2. Asphaltic treated paper for joint covering.

FIGURE 4
ABSORPTION TRENCH AND LATERAL DETAILS

5. Typical Layout: Septic Tank/Oxidation Pond System

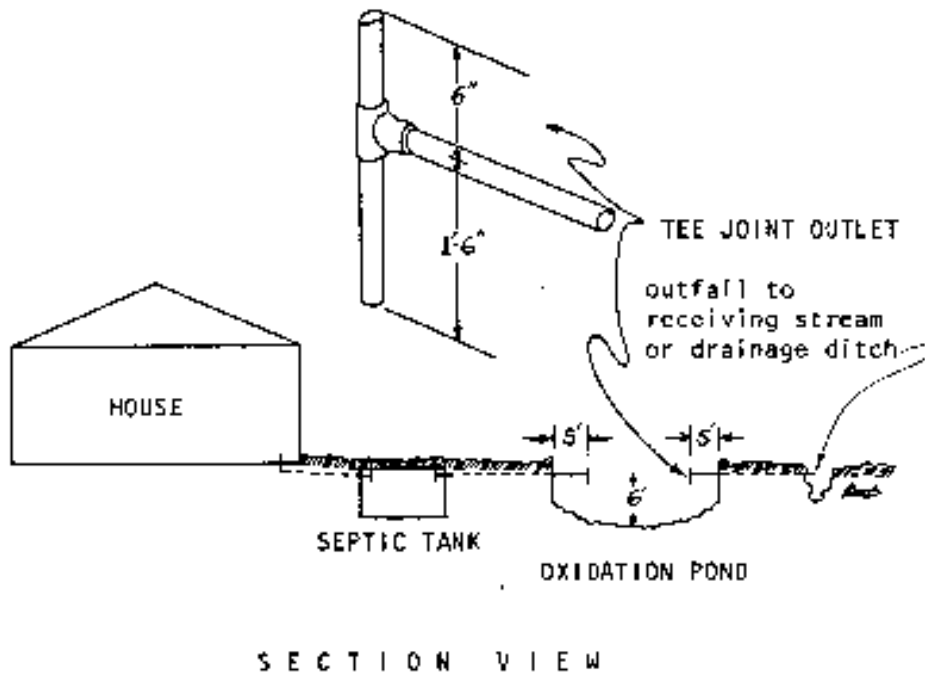
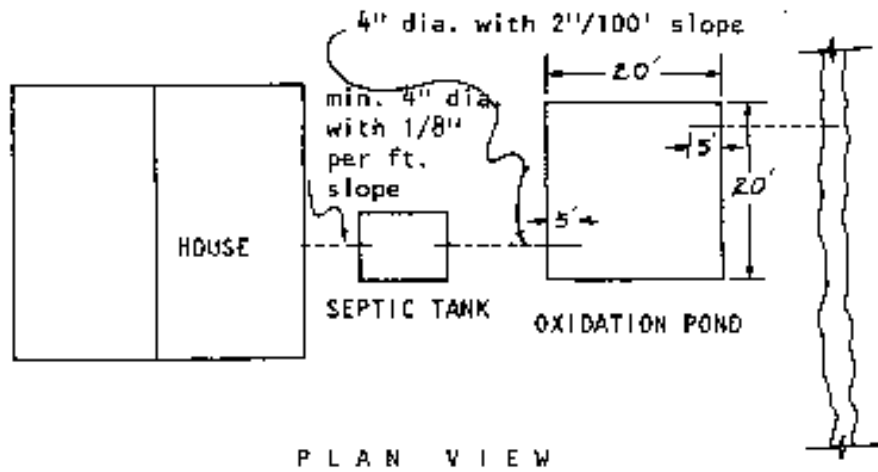

- NOTES: 1. Pond must be enclosed by a suitable fence.
 2. Outlet invert to be at same or lower elevation than inlet invert.
 3. Pond water surface at least 2" below septic tank water surface.

FIGURE 5
 TYPICAL LAYOUT: SEPTIC TANK/OXIDATION POND SYSTEM

6. Oxidation Pond Timber Retaining Wall Details

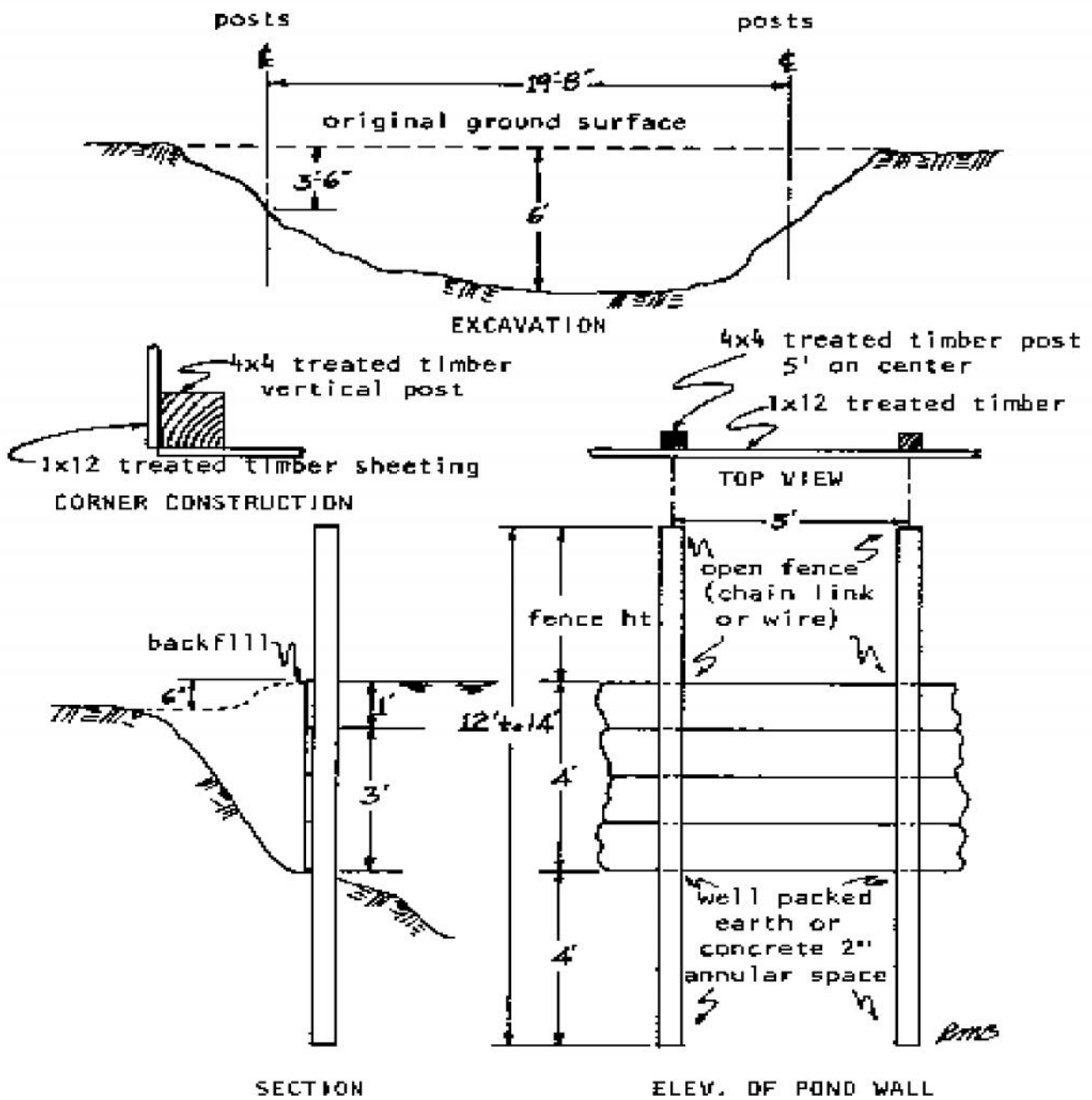

FIGURE 6
OXIDATION POND TIMBER RETAINING WALL DETAILS

7. Oxidation Pond Concrete Block Retaining Wall Details

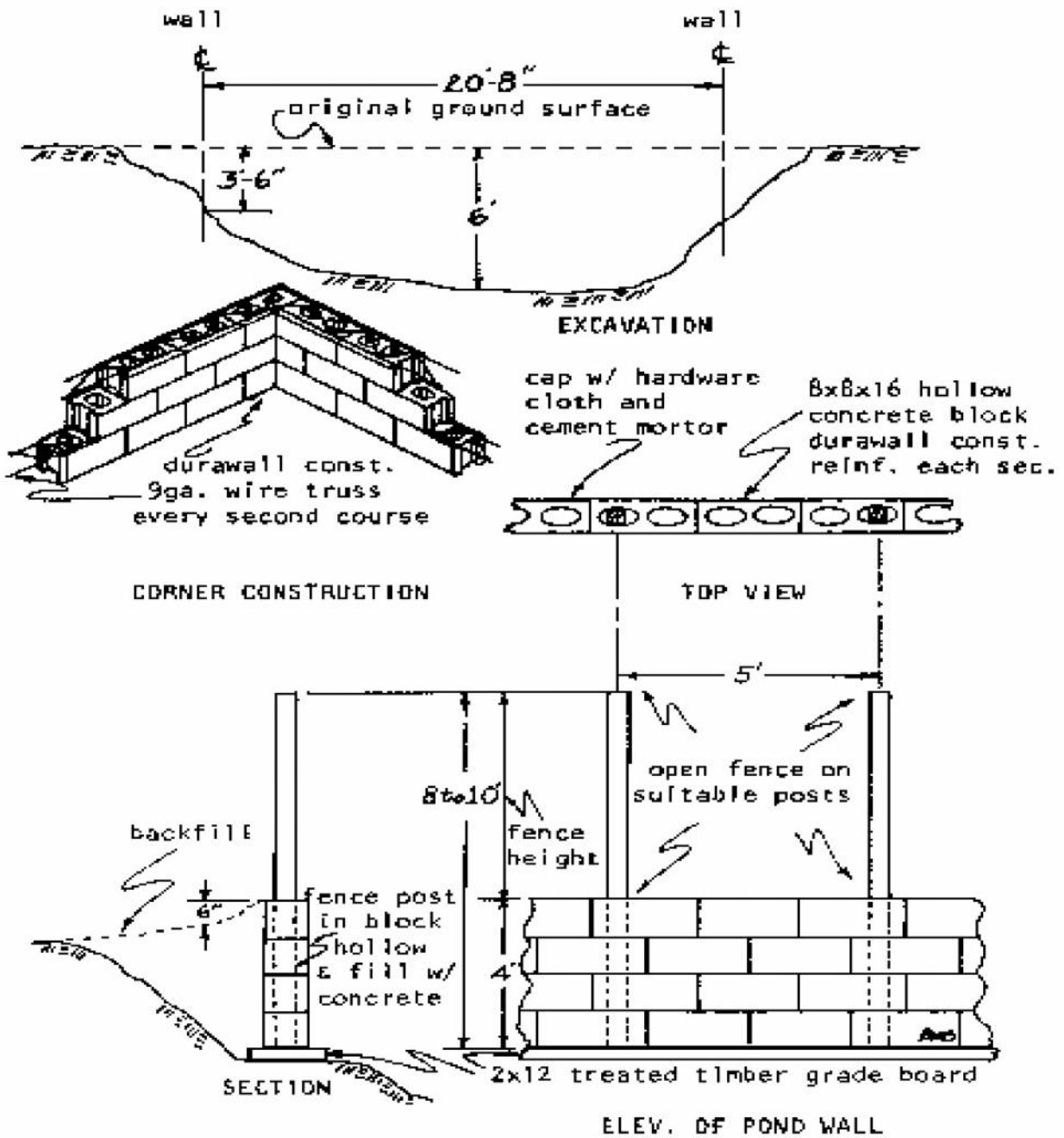

FIGURE 7

OXIDATION POND CONCRETE BLOCK RETAINING WALL DETAILS

8. Leveed Oxidation Pond

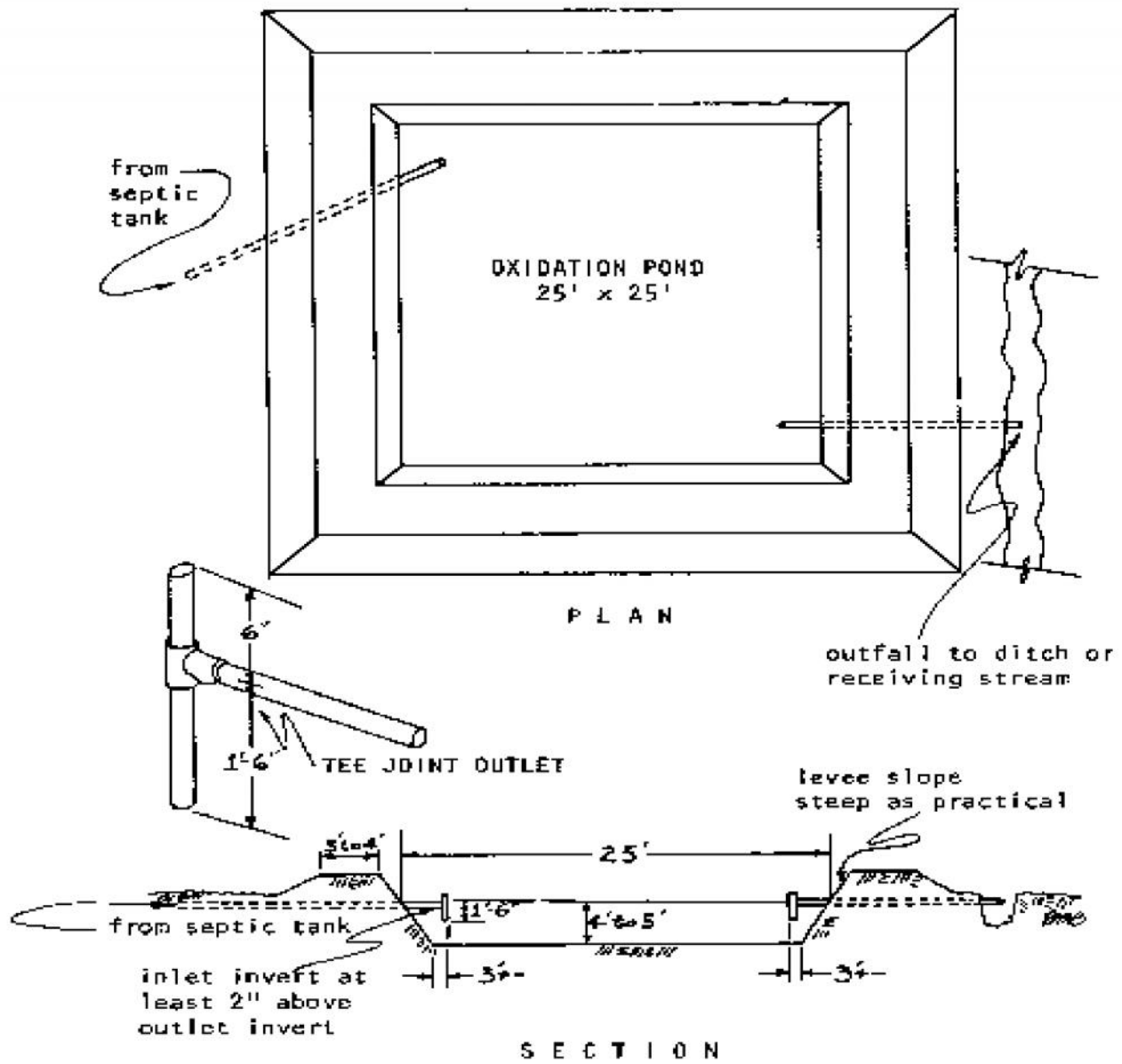
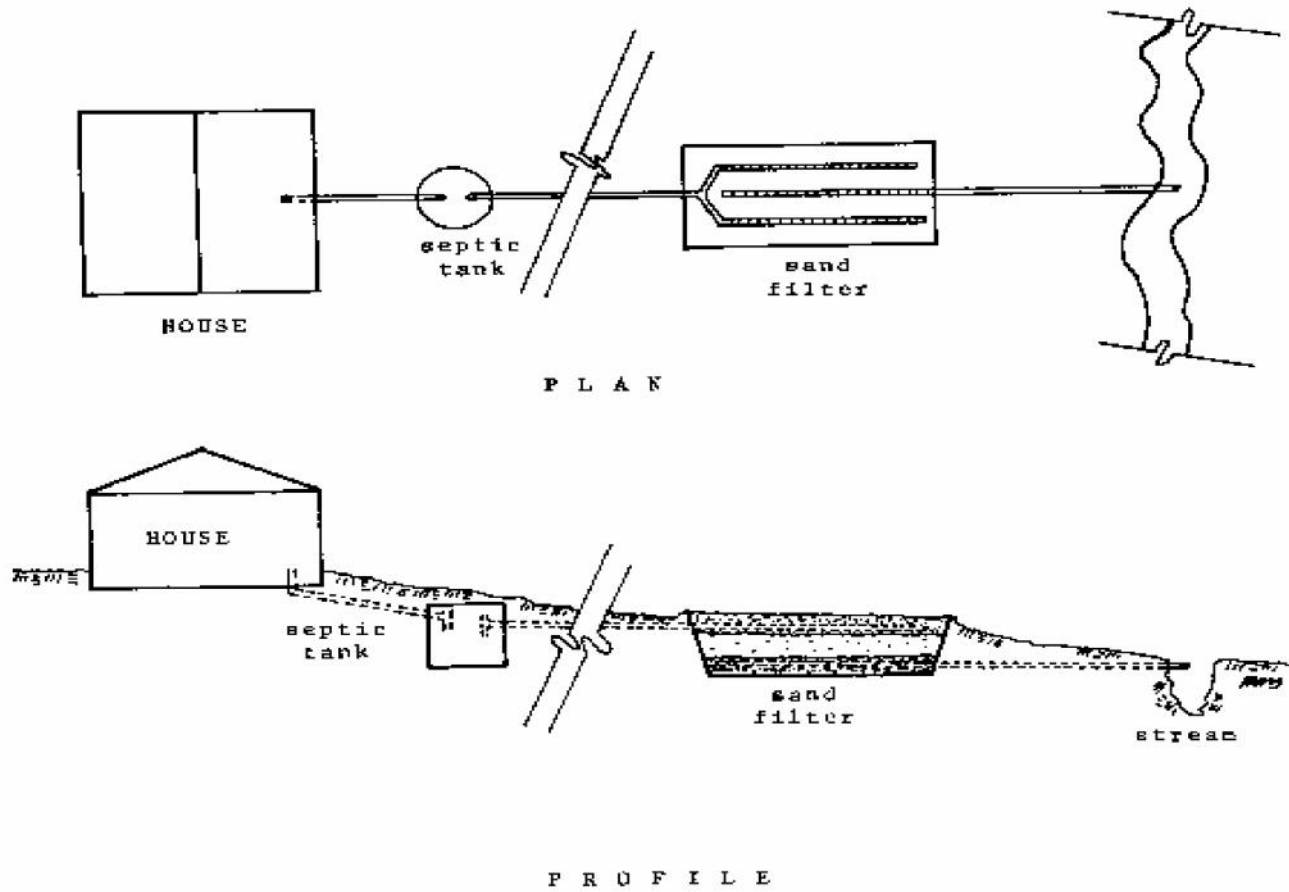

FIGURE 8
LEVEED OXIDATION POND

9. Typical Layout: Septic Tank/Sand Filter Bed System



NOTE: See Figure 10 for additional details

FIGURE 9
TYPICAL LAYOUT: SEPTIC TANK/SAND FILTER BED SYSTEM

10. Sand Filter Bed Details

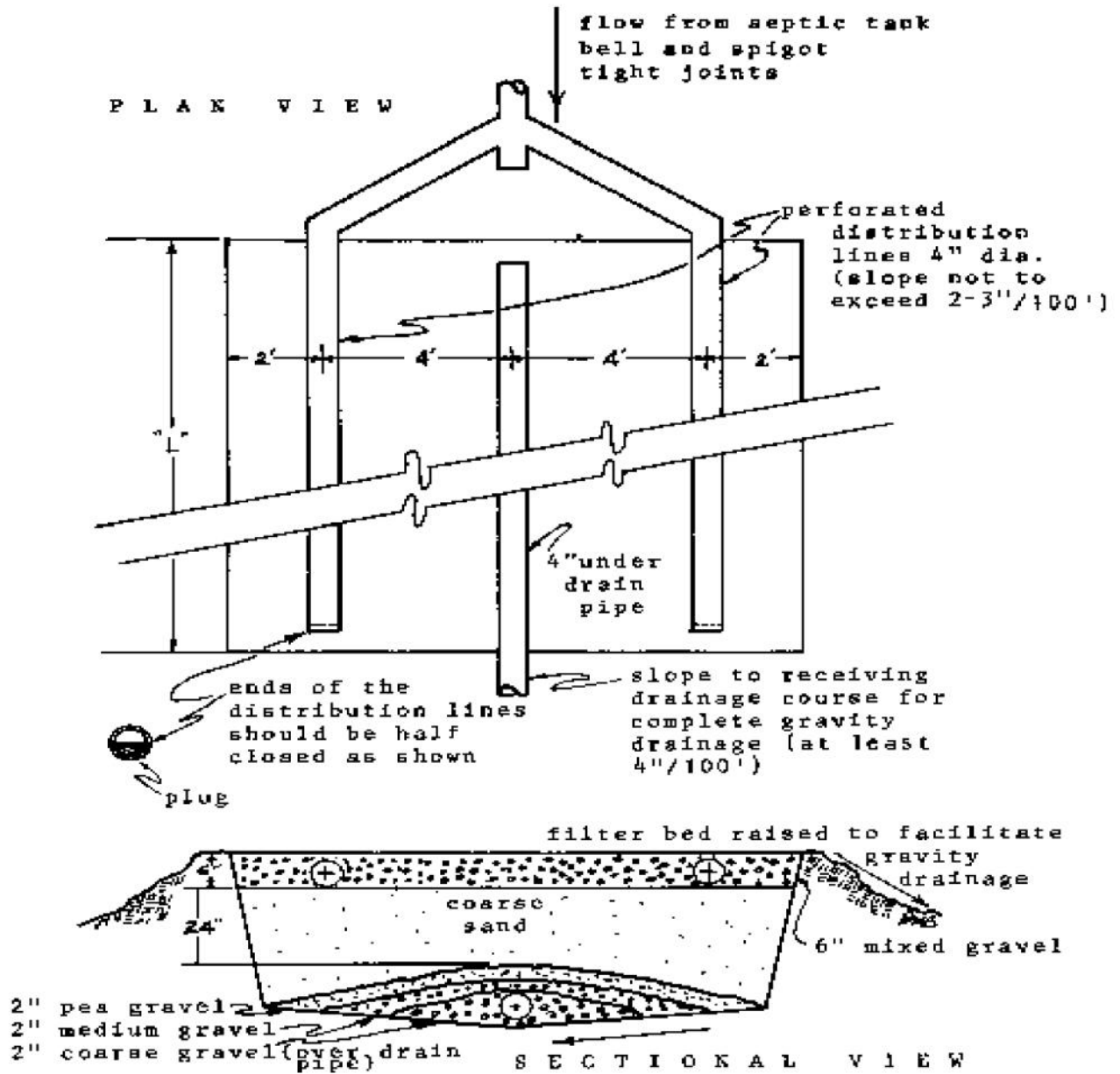

FIGURE 10
SAND FILTER BED DETAILS

CHLORINATOR

STACK FEED CHLORINATORS

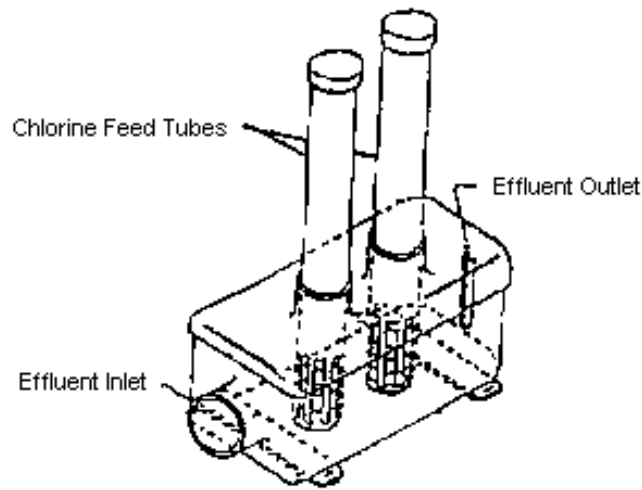

Figure 11

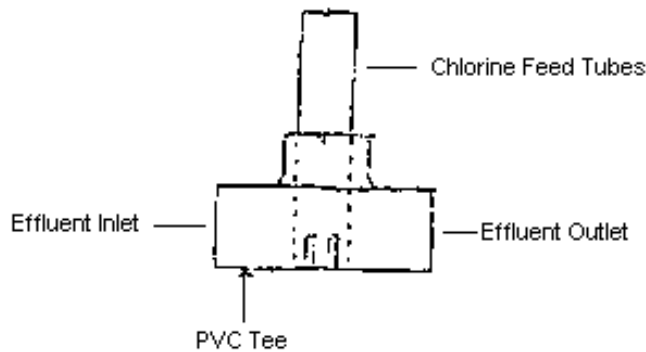

Figure 12

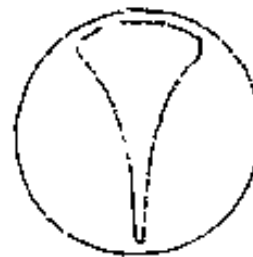

Figure 13

Chlorinators can be purchased premanufactured (as in Figure 11), or can be constructed onsite using the following minimum criteria - (Figure 12) Use a four-inch minimum PVC Tee with a restrictive insert (see Figure 13) to control the effluent flow. This allows the tablets to be contacted by the effluent in proportion to the amount of flow. The insert is cemented onto the PVC Tee with the restriction pointing down.

EFFLUENT REDUCTION TANKAGE

NOTE: ALL RISERS SHALL BE 3 INCHES ABOVE GRADE.

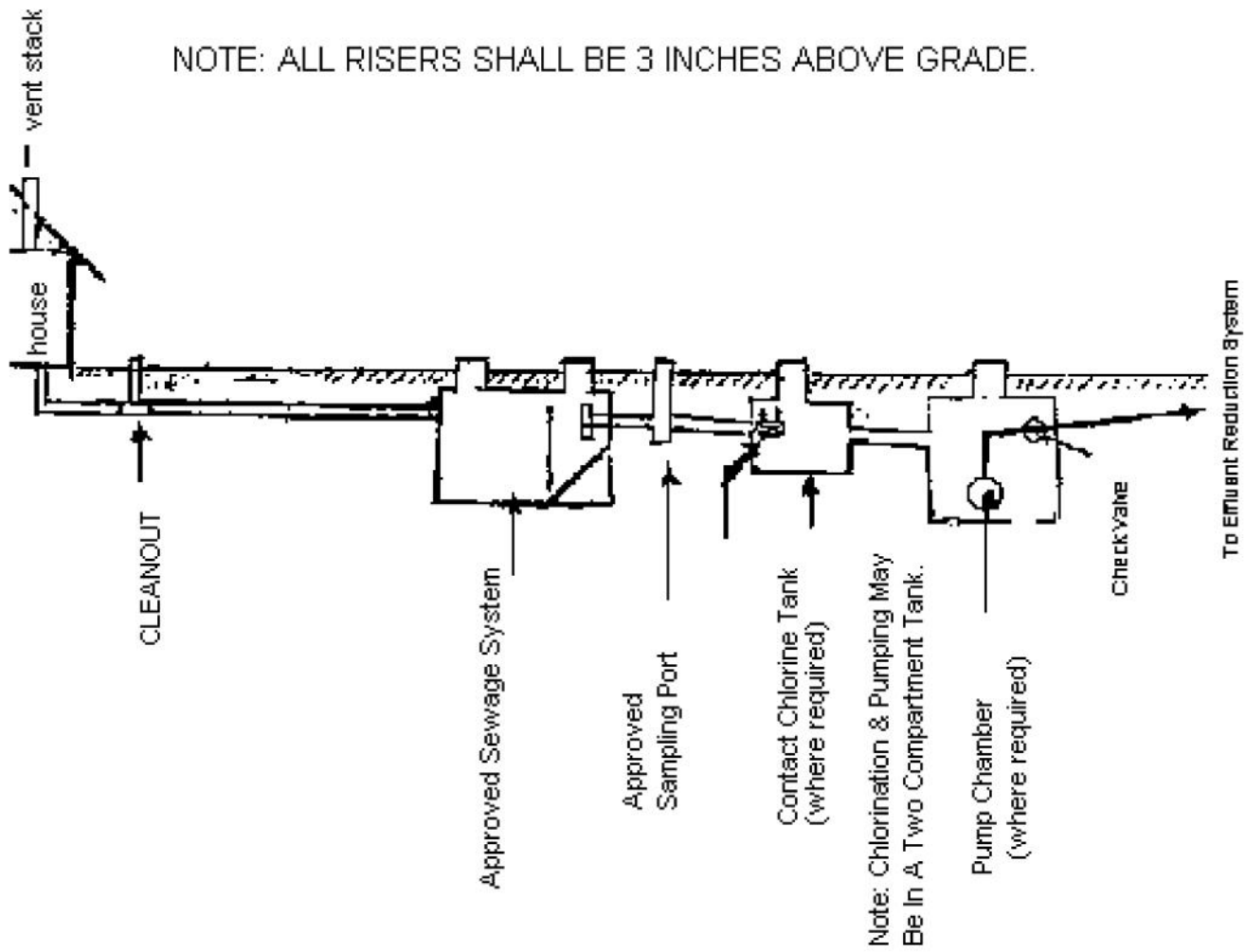

FIGURE 14

EFFLUENT REDUCTION FIELD

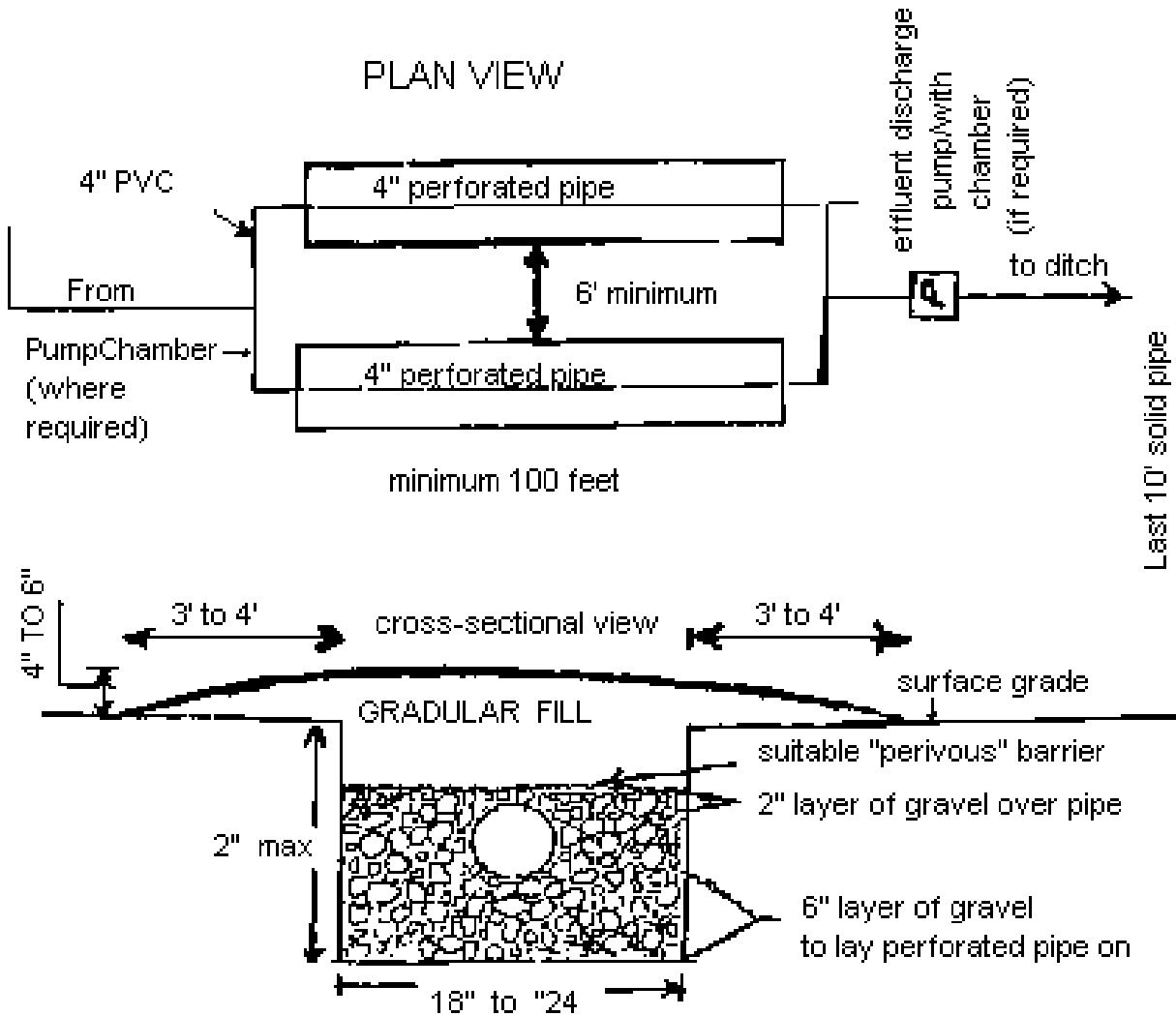

Figure 15

ROCK PLANT

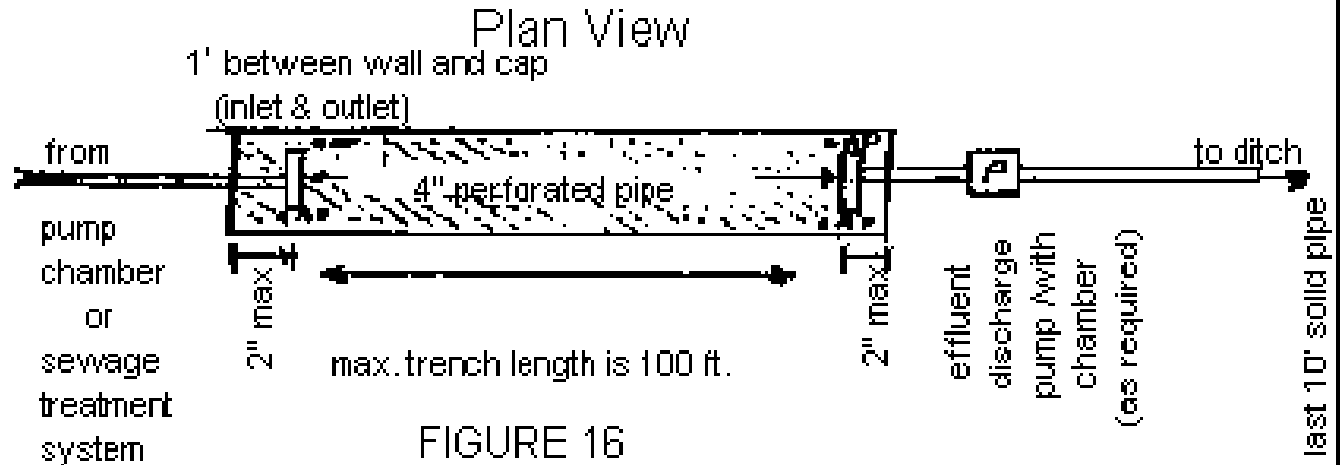

FIGURE 16

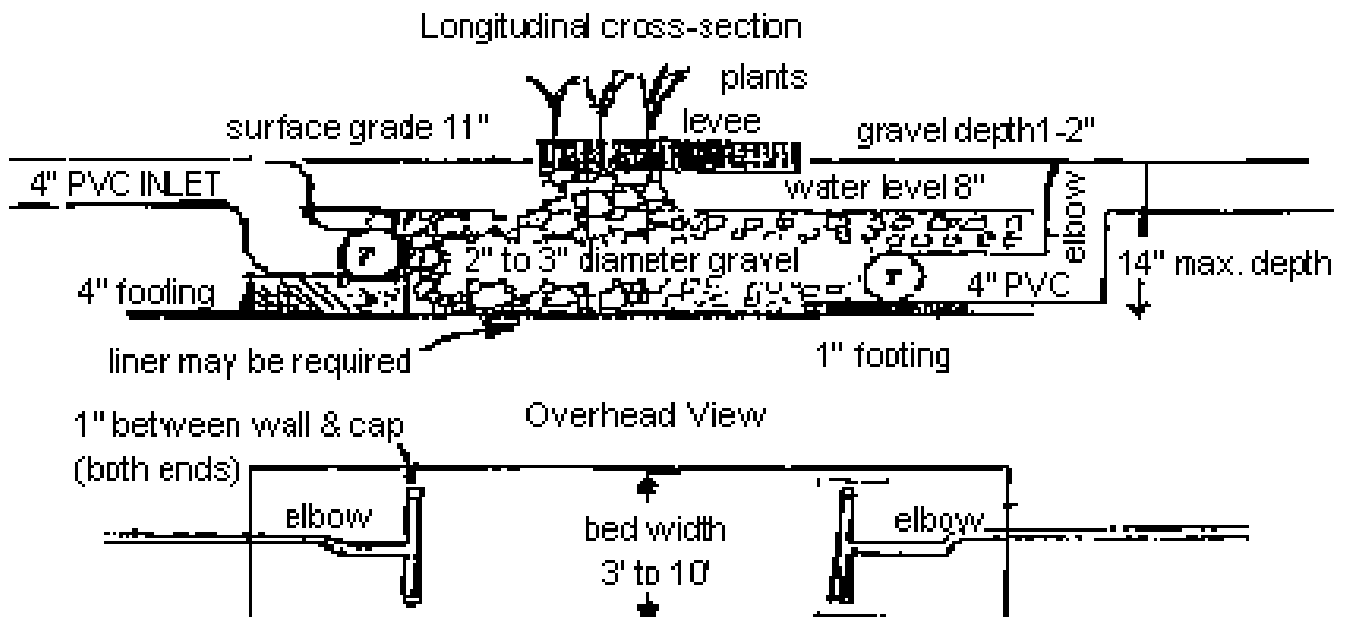

FIGURE 17

SPRAY IRRIGATION SCHEMATIC

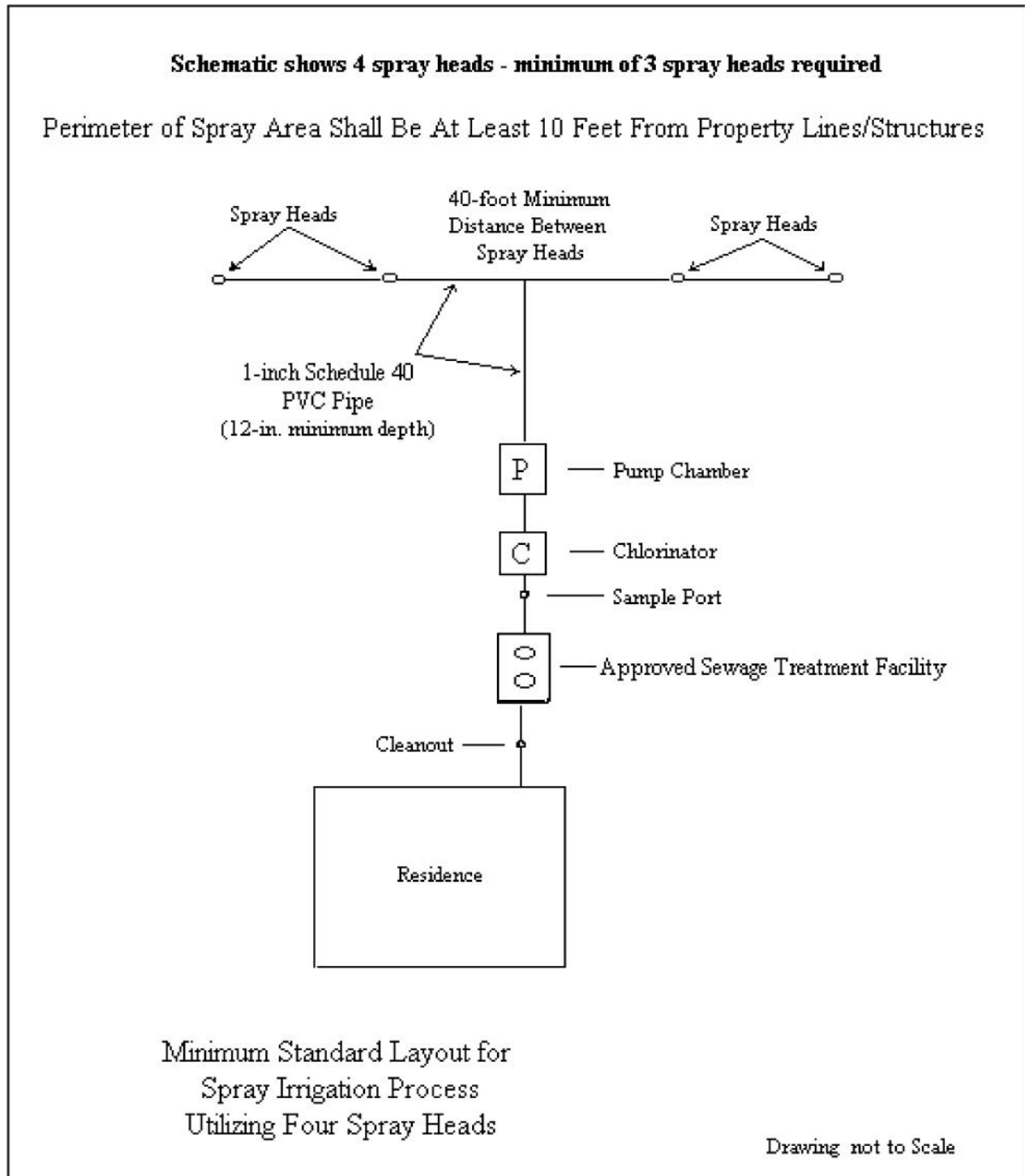

Figure 18

OVERLAND FLOW

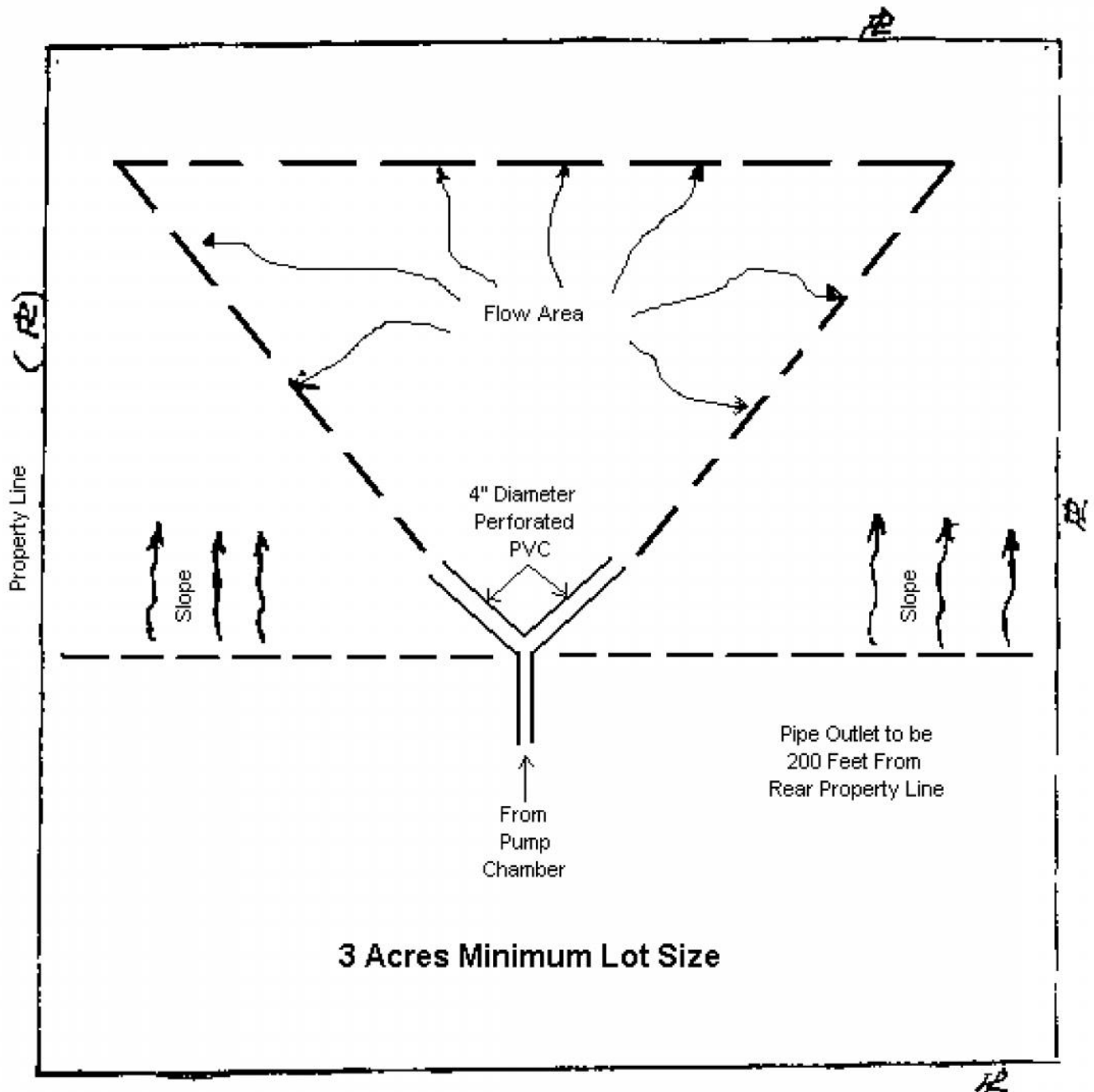
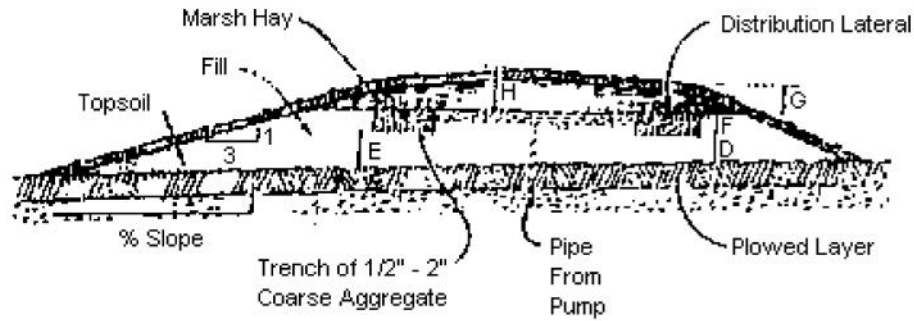

Figure 19

17. Mounds

MOUNDS



Cross Section of Mound System Using 2 Trenches for Absorption Area

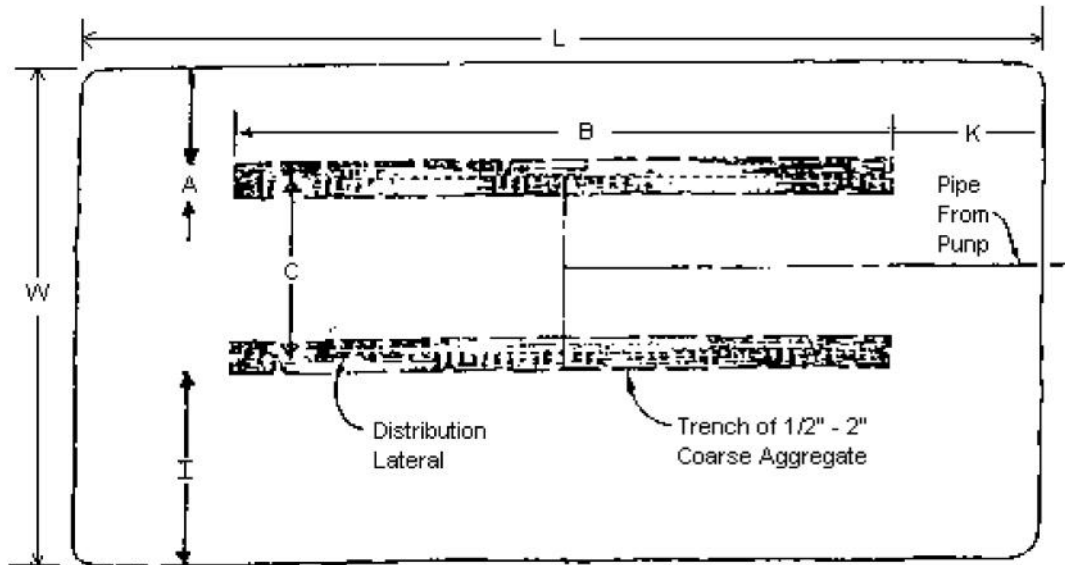

Plan View of Mound System Using 2 Trenches for Absorption Area

Figure 20

NOTE: MUST BE APPROVED BY OPH - ENGINEERING SERVICES
IN CONSULTATION WITH SANITARIAN REGIONAL DIRECTOR

DRIP DISPOSAL SYSTEM

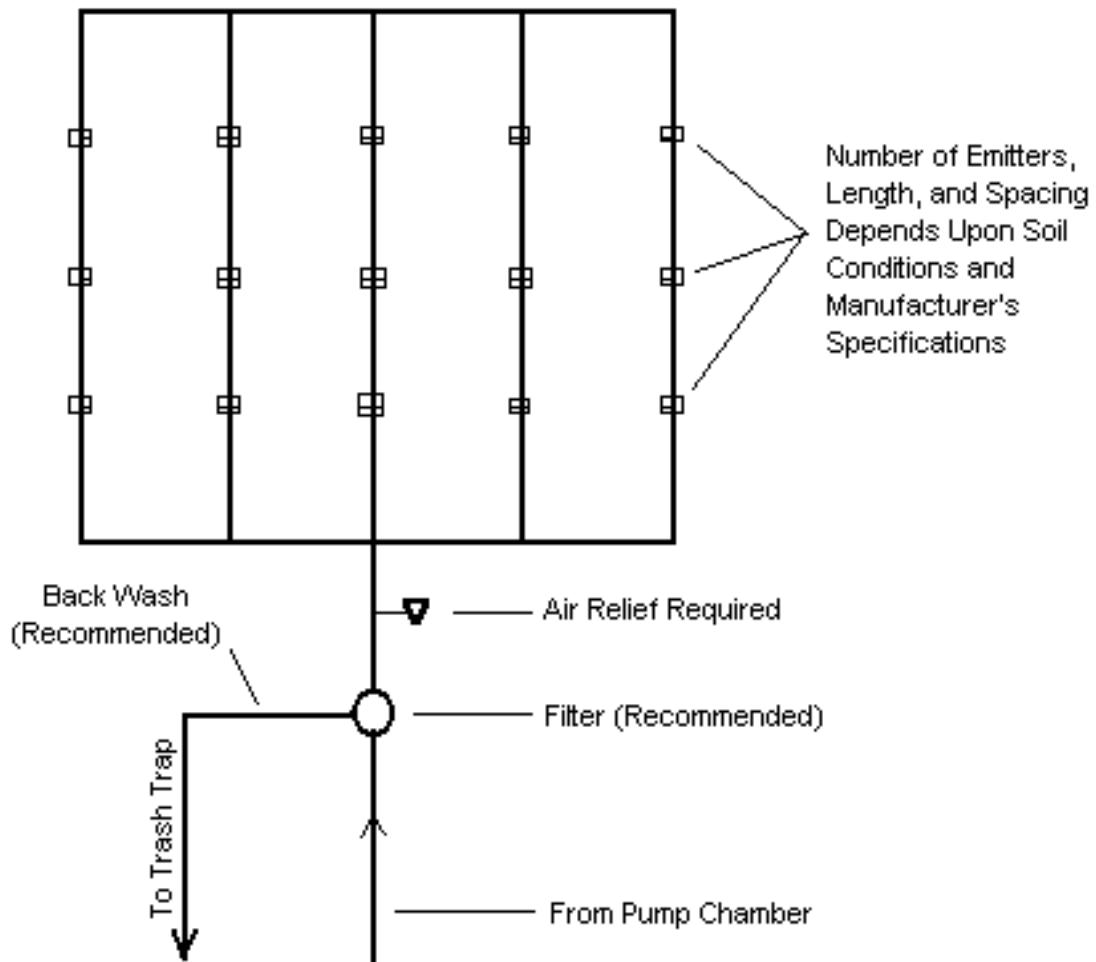

Line Depth - 6 inch Minimum to 18 inch Maximum
Line Separation - 2 foot Minimum

Figure 21

PUMPING CHAMBER FOR EFFLUENT REDUCTION

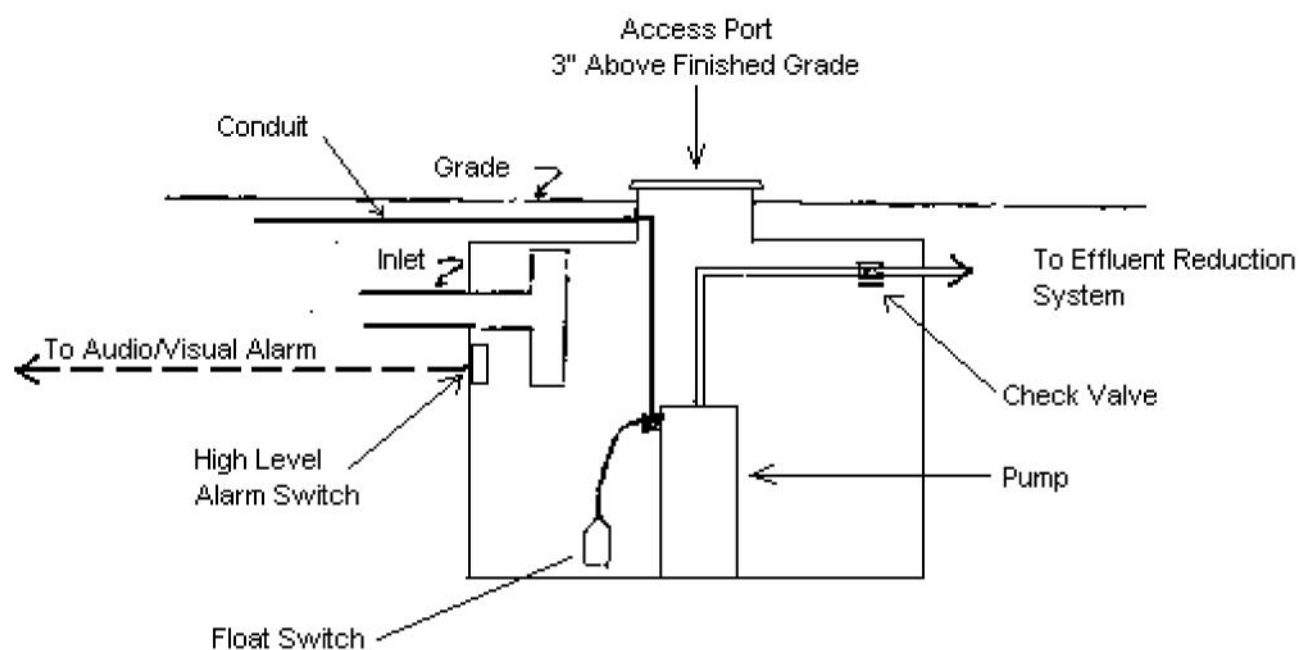

NOTE: Chlorination and Pumping May Be In A Two-Compartment Tank

Figure 22

AUTHORITY NOTE: Promulgated in accordance with R.S. 40:4(A)(6) and R.S. 40:5(9)(20).

HISTORICAL NOTE: Promulgated by the Department of Health and Hospitals, Office of Public Health, LR 28:1362 (June 2002).

